

SÛLION

LUZ

de exterior

**2021**

# ÍNDICE *INDEX*



**AQUARUM**  
47



**FAST**  
49



**LOPE**  
34



**SIA**  
56



**ARIS**  
42



**GRASS**  
29



**NALA**  
14



**SUKO**  
39



**BELY**  
52



**HELIO**  
70



**NAYA**  
20



**THIN**  
62



**BIRD**  
73



**INMA**  
42



**NEKO**  
72



**TISA**  
26



**BUILT**  
36



**KAMAL**  
54



**NEW ERA**  
24



**YUKA**  
66



**CANADIAN**  
38



**KIPPER**  
74



**NINA**  
18



**COBSOIL**  
44



**KOA**  
30



**OKO**  
42



**DARY**  
16



**LEIA**  
31



**PENN**  
58



**DOUCHE**  
48



**LOBY**  
28



**REGA**  
32

# LUZ DE EXTERIOR

**ES** El carácter natural de los espacios exteriores propicia la conexión con los cuatro elementos de la naturaleza otorgando a estos lugares el poder para evocar estados de paz, serenidad y descanso, que nos despiertan los mejores sentimientos.

Luz de Exterior ofrece una colección de luminarias destinadas a potenciar el estilo y la decoración de cualquier espacio al aire libre. La funcionalidad y la resistencia de los materiales se combinan con el diseño para dar como resultado una selección de luminarias que darán luz a los momentos más especiales.

**EN** *Outdoor spaces favour the connection with the four elements of nature, giving these places the power to evoke peace, serenity and rest, and to awake the best feelings in us.*

*Outdoor Light offers a collection of luminaries designed to enhance the style and decoration of any open space. The functionality and resistance of the materials are combined with the design to illuminate the most special moments.*

**PT** *O carácter natural dos espaços exteriores favorece a ligação com os quatro elementos da natureza, conferindo a estes locais a força de evocar estados de paz, serenidade e descanso, que despertam os melhores sentimentos.*

*Luz de Exterior oferece uma coleção de luminárias concebidas para realçar o estilo e a decoração de qualquer espaço exterior. A funcionalidade e resistência dos materiais aliam-se ao design para resultar numa selecção de luminárias que darão luz aos momentos mais especiais.*

**FR** *Le caractère naturel des espaces extérieurs encourage la connexion avec les quatre éléments de la nature, donnant à ces lieux le pouvoir d'évoquer des sensations de paix, de sérénité et de repos, qui éveillent les meilleurs sentiments.*

*Luz de Exterior propose une collection de lampes conçues pour renforcer le style et la décoration de tout espace extérieur. La fonctionnalité et la résistance des matériaux se combinent avec le design pour offrir une sélection de lampes qui éclaireront les moments les plus spéciaux.*











## UNA VIDA DE LUZ

**ES** La evolución consiste en una serie de transformaciones continuas que va experimentando la naturaleza y los seres que la componen. Esto es precisamente lo que Carlos y Regina Schuller, fundadores de SÛLION, han ido haciendo a lo largo de estos últimos 50 años, adaptándose a los continuos cambios, pero siempre con un mismo objetivo: crear espacios únicos que destilen personalidad.

La luz de SÛLION se enciende en 1966, cuando Carlos y Regina abren su primer taller de ensamblado de lámparas en Madrid, al que llamaron "Lámparas Schuller" y que, poco a poco, fue creciendo hasta convertirse en un referente en el diseño y la confección de lámparas artesanales. Por sus manos han pasado las últimas tendencias en iluminación decorativa de los años 80 y 90, desde farolitos, hasta sus tan exitosas lámparas florentinas y Tiffanys, que exportaron al resto de países de Europa, y también a Asia, África y Latinoamérica.

El estilo aplicado en cada diseño y el cuidado en la elección de sus materiales puestos al servicio de la luz, junto con el tesón y el esfuerzo de la familia Schuller, han llevado a SÛLION a convertirse en lo que es hoy en día.

**EN** Evolution is made of a bunch of continuous changes in the nature and its living beings. This is exactly what Carlos and Regina Schuller, founders of SÛLION, have been doing these last 50 years, adapting to the continuous changes, but always with the same target: create unique spaces with strong personality.

The light of SÛLION was turned on in 1966, when Carlos and Regina Schuller opened their first workshop of lamps assembly in Madrid, they named it "Lámparas Schuller", and step by step started growing until it was leader in design and assembly of handmade lamps. By their hands last trends have passed of the years 80 and 90, from small lamps to successful Florentine lamps and Tiffanys, which they exported to other countries of Europe, and to Asia, Africa and Latin America.

The style applied in each design and the careful selection of the materials used for the lights, allied with the hard work and the effort of the Schuller family, have transformed SÛLION in what it is nowadays.



**PT** A evolução consiste em uma série de transformações contínuas pelas quais passam a natureza e os seres que a compõem. É precisamente isso que Carlos e Regina Schuller, fundadores do SÛLION, têm feito nos últimos 50 anos, adaptando-se a mudanças contínuas, mas sempre com o mesmo objetivo: criar espaços únicos que exalem personalidade.

A luz SÛLION foi acesa em 1966, quando Carlos e Regina abriram em Madrid a sua primeira oficina de montagem de lâmpadas, que chamaram de "Lâmpadas Schuller" e que, aos poucos, foi se tornando uma referência em design e fabricação de lâmpadas feitas à mão. As últimas tendências em iluminação decorativa dos anos 80 e 90 passaram por suas mãos, desde as lanternas até as luminárias Florentinas e Tiffany de grande sucesso, que exportou para outros países europeus, além da Ásia, África e América Latina.

O estilo aplicado em cada desenho e o cuidado na escolha dos materiais a serviço da luz, aliados à tenacidade e esforço da família Schuller, fizeram com que a SÛLION se tornasse o que é hoje.

**FR** L'évolution consiste en une série de transformations continues que subissent la nature et les êtres qui la composent. C'est précisément ce qu'ont fait Carlos et Regina Schuller, fondateurs de SÛLION, au cours des 50 dernières années, en s'adaptant aux changements continus, mais toujours avec le même objectif: créer des espaces uniques qui respirent la personnalité.

La lumière de SÛLION a été allumée en 1966, lorsque Carlos et Regina ont ouvert leur premier atelier d'assemblage de lampes à Madrid, atelier qu'ils ont appelé «Lámparas Schuller» et qui, petit à petit, est devenu une référence dans la conception et la fabrication de lampes artisanales. Les dernières tendances de l'éclairage décoratif des années 80 et 90 sont passées entre ses mains, tant pour les lustres, comme pour les lampes florentines et Tiffany à succès, qu'il a exportées dans d'autres pays européens, ainsi qu'en Asie, en Afrique et en Amérique latine.

Le style appliqué dans chaque conception et le soin dans le choix des matériaux au service de la lumière, ainsi que la ténacité et l'effort de la famille Schuller, ont conduit SÛLION à devenir ce qu'elle est aujourd'hui.







# DÉJANOS ILUMINAR TU VIDA

**ES** En SÛLION damos luz a tus proyectos de renovación y reforma de hogares, oficinas, restaurantes, hoteles, etc. Nuestro equipo de lighting designers te acompañará en el desarrollo de tus ideas transformándolas en espacios vivos y con personalidad propia.

Trabajamos para ofrecerte las mejores soluciones de iluminación y ventilación, sin dejar de lado la eficiencia, la durabilidad y la elegancia. Entendemos la luz como energía que tiene el poder de transformar una casa en un hogar y la capacidad de enriquecer cada espacio creando emociones y sensaciones únicas.

**PT** Na SÛLION damos origem aos seus projetos de renovação e reforma de habitações, escritórios, restaurantes, hotéis, etc. A nossa equipa de designers de iluminação irá acompanhá-lo no desenvolvimento das suas ideias, transformando-as em espaços habitacionais com personalidade própria.

Trabalhamos para lhe oferecer as melhores soluções de iluminação e ventilação, sem descurar a eficiência, durabilidade e elegância. Entendemos a luz como a energia que tem o poder de transformar uma casa em um lar e a capacidade de enriquecer cada espaço criando emoções e sensações únicas.

**EN** At SÛLION we give light to your projects of renewal for homes, offices, restaurants, hotels... Our team of lighting designers will help you in the development of your ideas, transforming them into living places and with their own personality.

We offer the best solutions for lighting and ventilation, keeping in mind efficiency, durability, and elegance. We understand the light as energy, that have the power to transform a house in a home, and is also able to make each room better, creating unique feelings and sensation.

**FR** Chez SÛLION nous donnons naissance à vos projets de création et de réforme de foyers, bureaux, restaurants, hôtels, etc. Notre équipe de "lighting designers" vous accompagnera dans le développement de vos idées, en les transformant en espaces de vie ayant leur propre personnalité.

Nous travaillons pour vous offrir les meilleures solutions d'éclairage et de ventilation, sans négliger l'efficacité, la durabilité et l'élégance. Nous comprenons la lumière comme une énergie qui a le pouvoir de transformer une maison en un foyer et la capacité d'enrichir chaque espace en créant des émotions et des sensations uniques.



# MIRAMOS AL FUTURO

REGINA  
SCHULLER

**ES** Nuestra apuesta por el diseño, unido a la innovación y al desarrollo tecnológico, es una constante. Concebimos cada uno de nuestros productos como piezas únicas para personas que también lo son. Con esta filosofía nace **REGINA SCHULLER**, un proyecto que nos permite mirar al futuro manteniendo viva la esencia de nuestra marca.

**REGINA SCHULLER** es sinónimo de fuerza y de carácter, la expresión de la elegancia, combinada con la sencillez y la funcionalidad. Señas de identidad que son compartidas por nuestro equipo de profesionales que trabaja para construir hogares y estancias que den respuesta a las necesidades de las personas en su día a día.

**EN** *Our commitment to design, together with innovation and technological development, is a key component. We design each of our products as unique pieces for people who are also unique. **REGINA SCHULLER** was born with this philosophy, a project that allows us to look to the future while keeping the essence of our brand alive.*

*Regina Schuller is synonymous of strength and character, the expression of elegance, combined with simplicity and functionality. Signs of identity that are shared by our team of professionals who work to build homes that respond to the needs of people in their daily lives.*

**PT** *O nosso compromisso com o design, aliado à inovação e ao desenvolvimento tecnológico, é uma constante. Concebemos cada um dos nossos produtos como peças únicas para pessoas que também o são. **REGINA SCHULLER** nasceu com esta filosofia, um projeto que nos permite olhar para o futuro mantendo viva a essência da nossa marca.*

**REGINA SCHULLER** é sinônimo de força e caráter, expressão da elegância, aliada à simplicidade e funcionalidade. Sinais de identidade que são compartilhados pela nossa equipe de profissionais que se dedica à construção de casas e quartos que respondam às necessidades das pessoas no seu dia-a-dia.

**FR** *Notre engagement pour le design, associé à l'innovation et au développement technologique, est une constante. Nous concevons chacun de nos produits comme des pièces uniques pour les personnes qui le sont aussi. **REGINA SCHULLER** est née avec cette philosophie, un projet qui nous permet de regarder vers l'avenir tout en gardant vivante l'essence de notre marque.*

**REGINA SCHULLER** est synonyme de force et de caractère, l'expression de l'élégance, allée à la simplicité et à la fonctionnalité. Des signes d'identité partagés par notre équipe de professionnels qui travaillent pour construire des foyers et des pièces qui répondent aux besoins des personnes dans leur vie quotidienne.









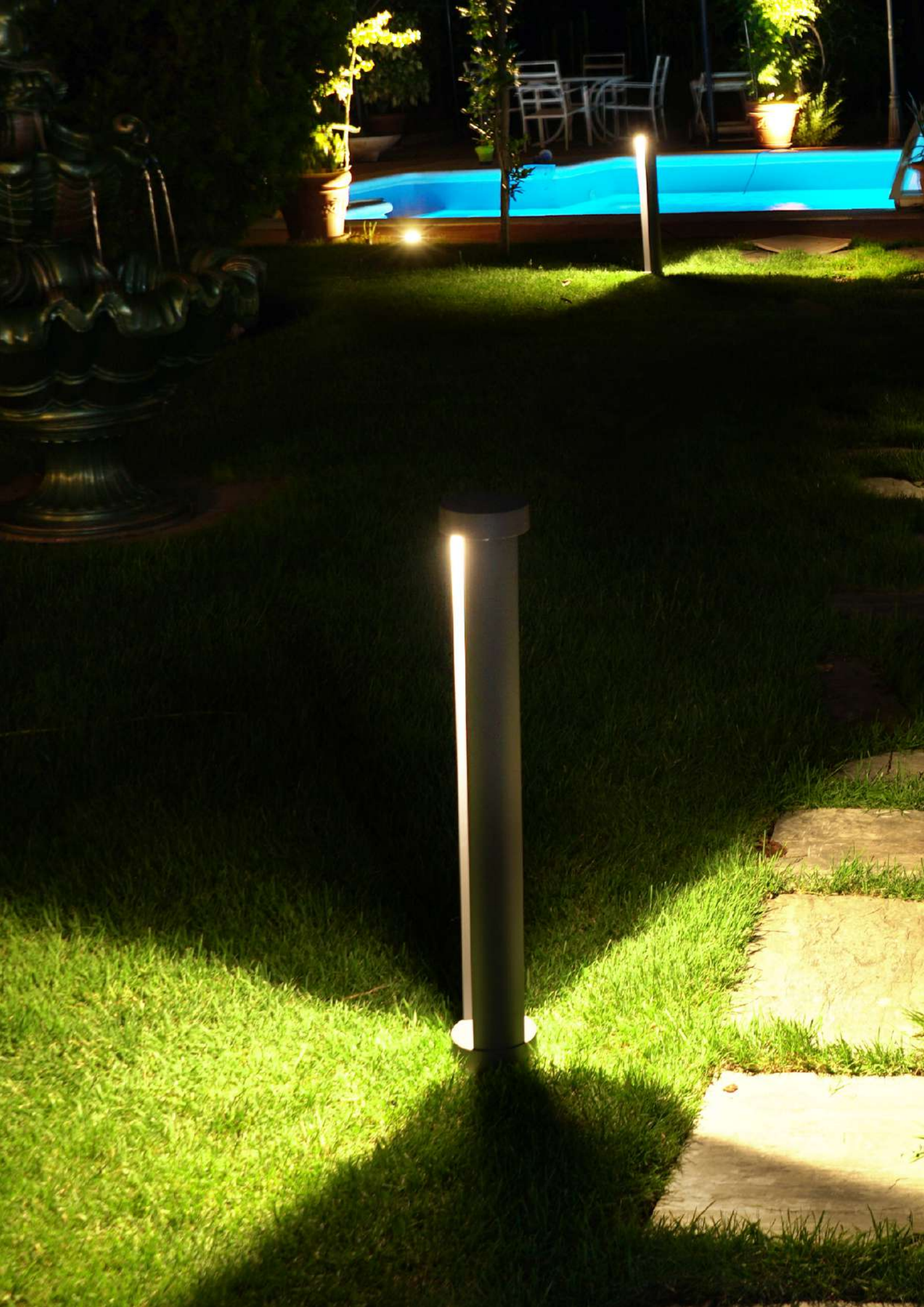



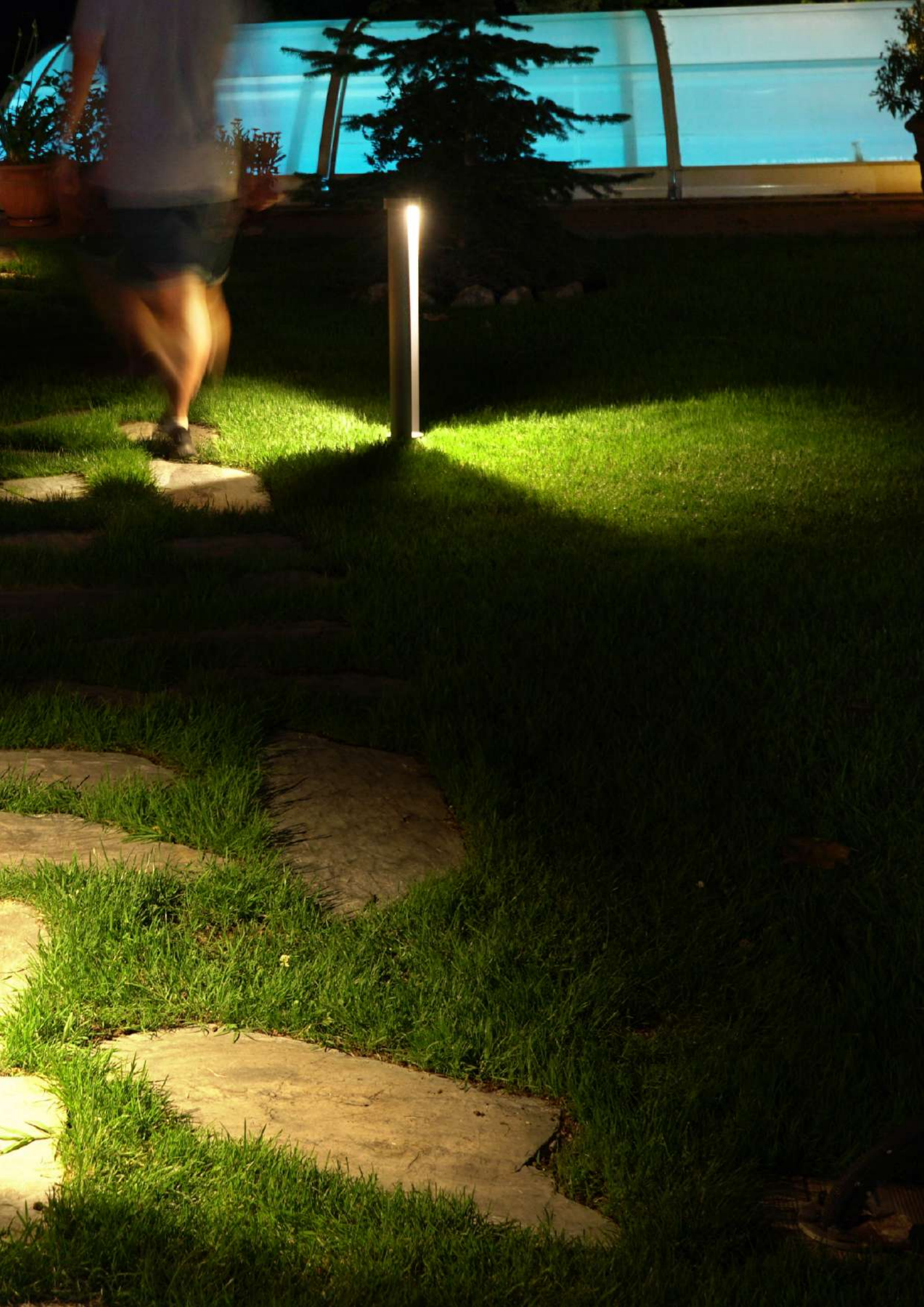



# NALA

by  
REGINA  
SCHULLER





**NALA**

BALIZAS

LED COB AC 100-240V 50-60Hz

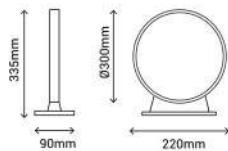

Material

**300010** 6 W 450 lm 3000 K Gris antracita RAL 7012

**NALA**

BALIZAS

LED COB AC 100-240V 50-60Hz

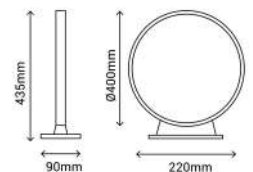

Material

**300011** 6 W 450 lm 3000 K Gris antracita RAL 7012



REF/300010

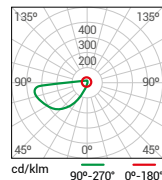

REF/300011

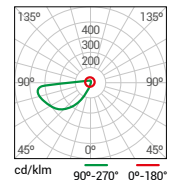





**DARY**





**DARY**

**BALIZAS**

LED COB AC 100-240V 50-60Hz

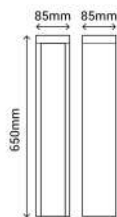

Material

**200764** 10 W 800 lm 3000 K Gris antracita RAL 7012

**DARY**

**BALIZAS**

LED COB AC 100-240V 50-60Hz

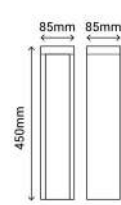

Material

**400064** 10 W 800 lm 3000 K Gris antracita RAL 7012

- 
- 
- 
- 
- 
- 
- 
- 
- 

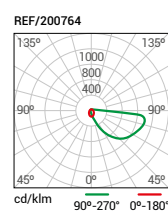

- 
- 
- 
- 
- 
- 
- 
- 
- 

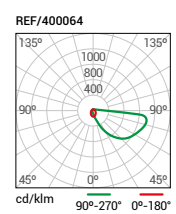



**NINA**





**NINA**

**BALIZAS**

LED COB AC 100-240V 50-60Hz

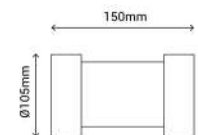

Material **M** **V**

**400061** 9 W 600 lm 3000 K Gris antracita RAL 7012



°C -20~ +50°C

IP 54

IK 06



15000

20000 h

REF/400061

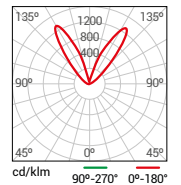

**NINA**

**BALIZAS**

LED COB AC 100-240V 50-60Hz

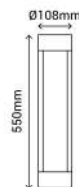

Material **M** **V**

**400063** 9 W 600 lm 3000 K Gris antracita RAL 7012



°C -20~ +50°C

IP 54

IK 06



15000

20000 h

REF/400063

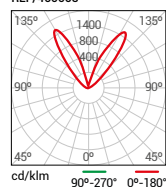

**NINA**

**BALIZAS**

LED COB AC 100-240V 50-60Hz

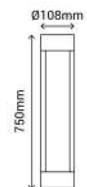

Material **M** **V**

**400069** 9 W 600 lm 3000 K Gris antracita RAL 7012



°C -20~ +50°C

IP 54

IK 06



15000

20000 h

REF/400069

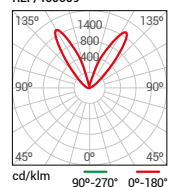





# NAYA





**NAYA**

**APLIQUES**

LED SMD AC 100-240V 50-60Hz

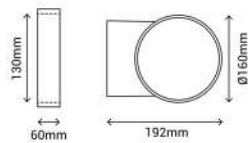

Material

**400045** 12 W 1000 lm 3000 K Gris antracita RAL 7012

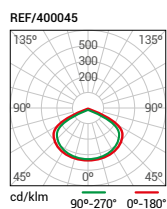
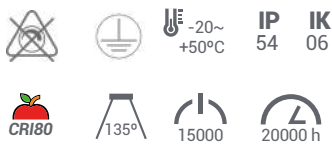

**NAYA**

**BALIZAS**

LED SMD AC 100-240V 50-60Hz

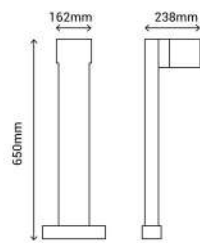

Material

**400065** 12 W 1000 lm 3000 K Gris antracita RAL 7012

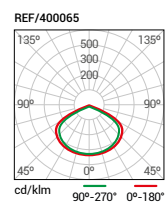
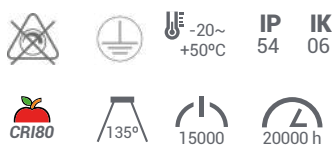









# NEW ERA





**NEW ERA**

**APLIQUES**

LED SMD AC 220-240V 50-60Hz

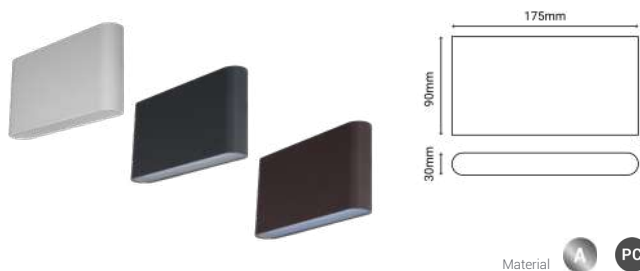

Material	Model	Power (W)	Lumen (lm)	Color Temp (K)	Finish
PC	112180	12	850	3000	Blanco RAL 9003
PC	400202	12	850	3000	Gris antracita RAL 7012
PC	400203	12	850	3000	Marrón RAL 8025
PC	400205	12	850	4000	Blanco RAL 9003
PC	400206	12	850	4000	Gris antracita RAL 7012
PC	400204	12	850	4000	Marrón RAL 8025

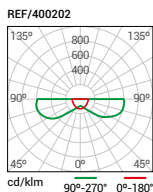

A glowing, angular light fixture, possibly a recessed ceiling light, is shown against a dark, textured background. The light fixture is illuminated from within, creating a warm, yellowish glow. The background has a mottled, grainy appearance, suggesting a concrete or stone surface. The light fixture is positioned diagonally across the frame, with the word "TISA" overlaid on it.

**TISA**





**TISA**

**APLIQUES**

LED SMD AC 220-240V 50-60Hz

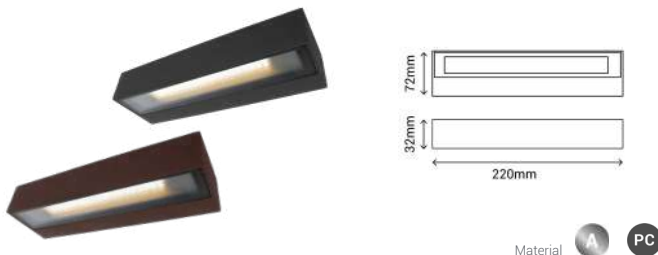

Material **A** **PC**

<b>112272</b>	12 W	600 lm	3000 K	Gris antracita RAL 7012
<b>112358</b>	12 W	600 lm	3000 K	Acero cortén
<b>112972</b>	12 W	640 lm	4000 K	Gris antracita RAL 7012
<b>112958</b>	12 W	640 lm	4000 K	Acero cortén



**TISA**

**APLIQUES**

LED SMD AC 220-240V 50-60Hz

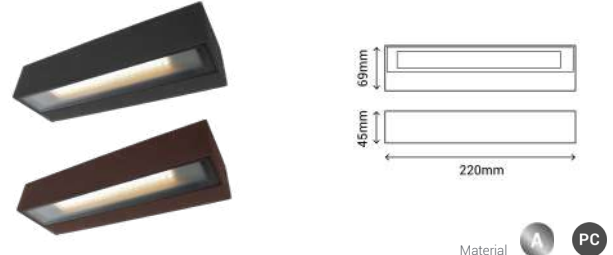

Material **A** **PC**

<b>112287</b>	2x8 W	2x500 lm	3000 K	Gris RAL 7042
<b>112271</b>	2x8 W	2x500 lm	3000 K	Acero cortén

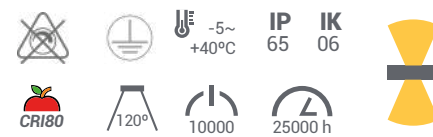



LOBY



**LOBY**

**APLIQUES**

LED COB AC 110-240V 50-60Hz



Material 

<b>400086</b>	12 W	850 lm	3000 K	Negro RAL 9005
<b>400087</b>	12 W	850 lm	3000 K	Gris antracita RAL 7012
<b>400088</b>	12 W	850 lm	3000 K	Marrón RAL 8025
<b>400092</b>	12 W	850 lm	4000 K	Negro RAL 9005
<b>400095</b>	12 W	850 lm	4000 K	Gris antracita RAL 7012
<b>400600</b>	12 W	850 lm	4000 K	Marrón RAL 8025



$\text{IE}$  -20~  
+50°C

IP 54 IK 06



CRI80



120°



15000



25000 h

REF/400086

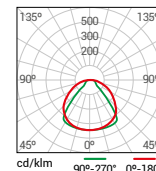



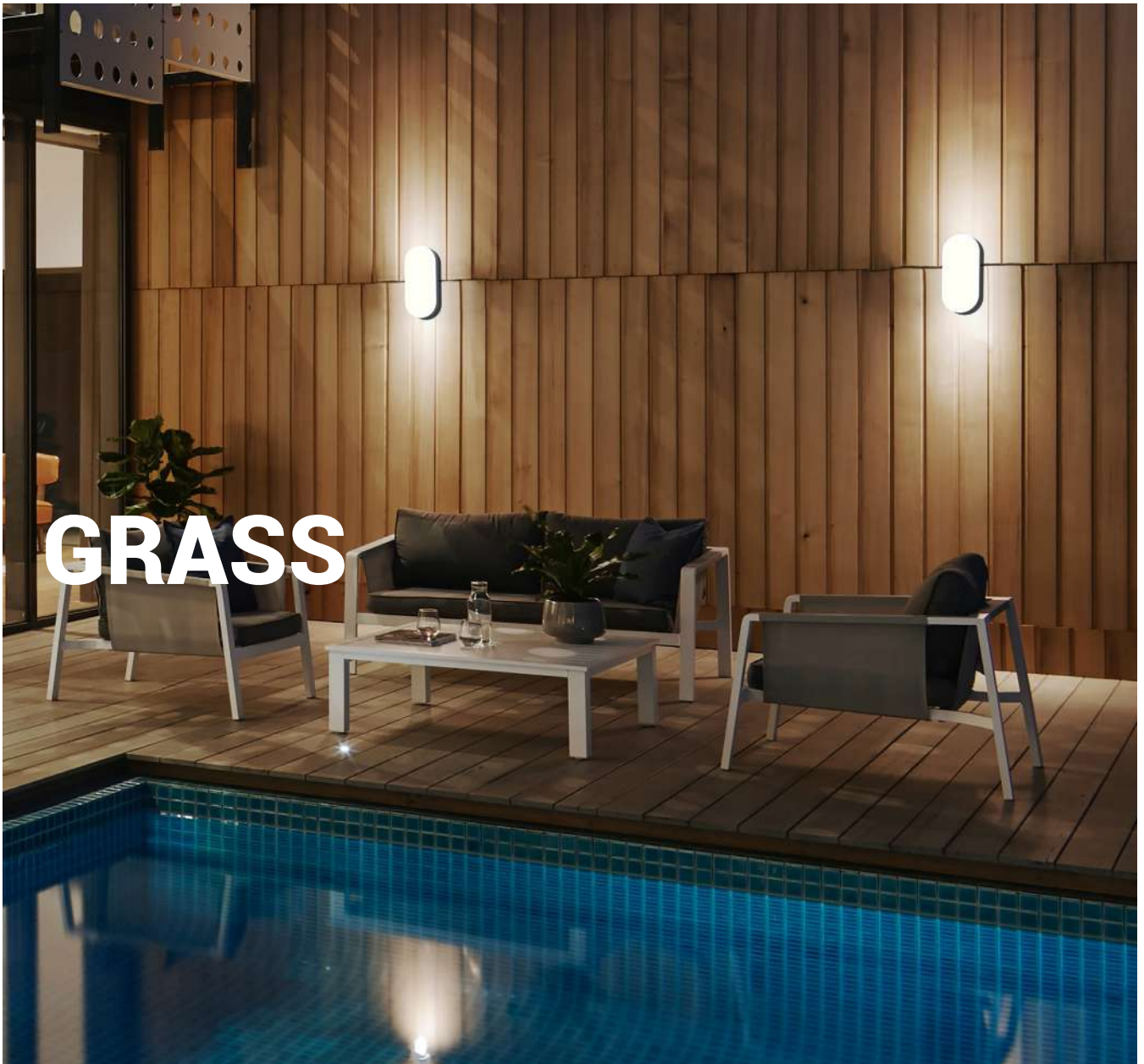

# GRASS

## GRASS

LED SMD AC 220-240V

### APLIQUES

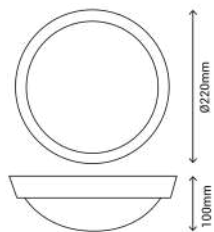

Material **ABS**

**101183** 18 W 1300 lm 4000 K Blanco RAL 9003

## GRASS

LED SMD AC 220-240V

### APLIQUES

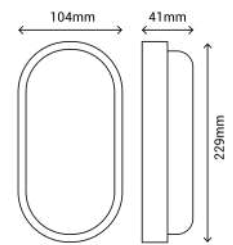

Material **ABS**

**100763** 18 W 1300 lm 4000 K Blanco RAL 9003

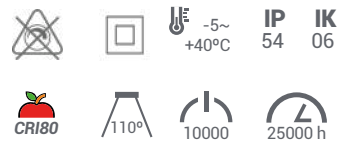
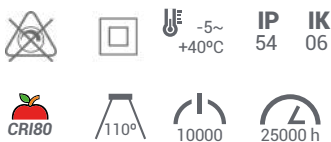



# KOA



## KOA

APLIQUES

LED SMD AC 100-240V 50-60Hz



Material **ABS**

<b>200677</b>	7 W	650 lm	3000 K	Blanco RAL 9003
<b>200776</b>	7 W	650 lm	3000 K	Negro RAL 9005
<b>200679</b>	7 W	650 lm	4000 K	Blanco RAL 9003
<b>200678</b>	7 W	650 lm	4000 K	Negro RAL 9005



REF/200677

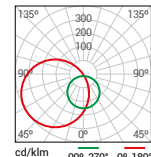





**LEIA**

**APLIQUES**

AC Max. 250V 50-60Hz



Material

<b>400072</b>	1 x E27	Gris antracita RAL 7012 / Blanco
<b>400073</b>	1 x E27	Marrón RAL 8025 / Blanco





**REGA**





**REGA**

AC Max. 250V 50-60Hz

**APLIQUES**

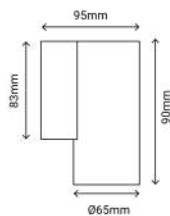

Material

<b>400900</b>	1 xGU10	Gris antracita RAL 7012
<b>400901</b>	1 xGU10	Marrón RAL 8025

**REGA**

AC Max. 250V 50Hz

**APLIQUES**

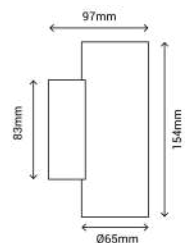

Material

<b>400902</b>	2 xGU10	Gris antracita RAL 7012
<b>400903</b>	2 xGU10	Marrón RAL 8025

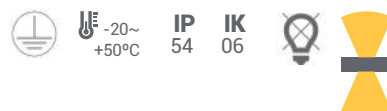
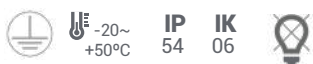

LOPE







**LOPE**

**APLIQUES**

LED AC Max. 250V 50-60Hz

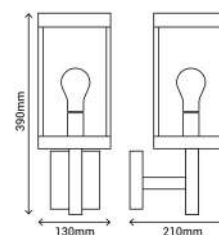

Material

**700201** 1 xE27 Gris antracita RAL 7012



**LOPE**

**APLIQUES**

LED AC Max. 250V 50-60Hz

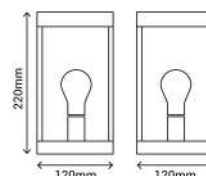

Material

**700200** 1 xE27 Gris antracita RAL 7012



**LOPE**

**COLGANTES**

LED AC Max. 250V 50-60Hz

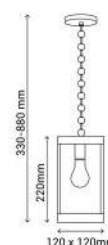

Material

**700202** 1 xE27 Gris antracita RAL 7012



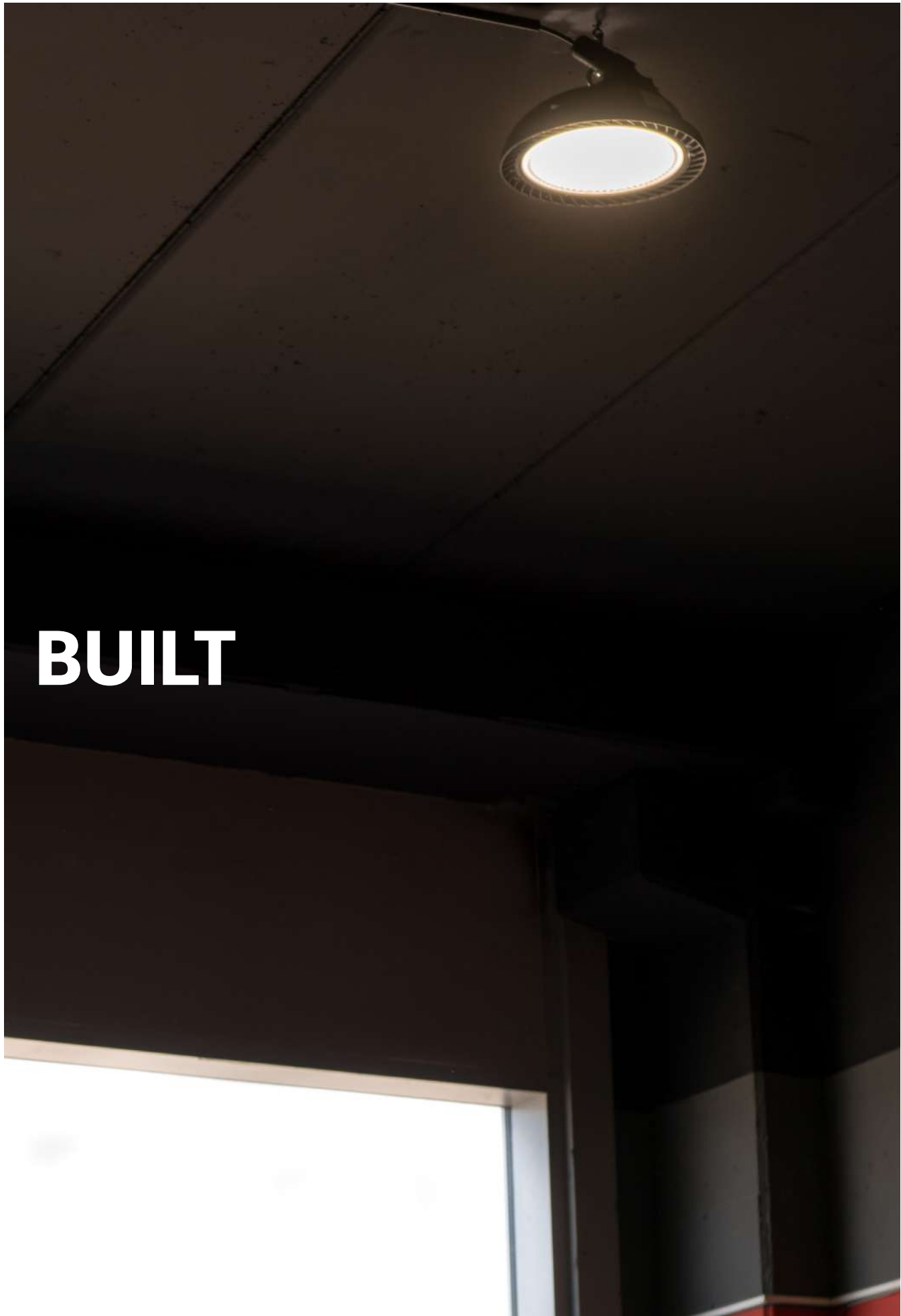

**BUILT**



400W HPI

100W BUILT

HASTA | UP TO  
**62'5%**

AHORRO | SAVING

Sustitución de campanas industriales con lámpara de halogenuro metálico en 250W y 400W por campanas de LED en 100W y 150W.

Replacement 250W and 400W HPI luminaries by 100W and 250W LED luminaries.

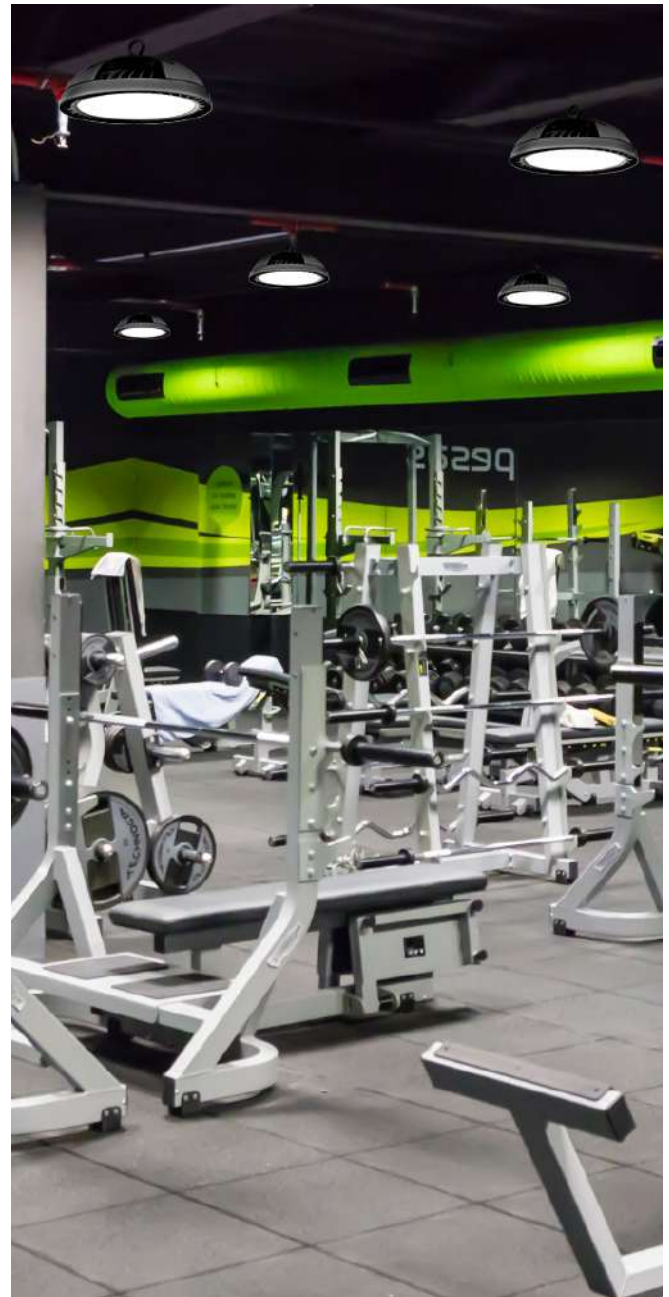

**BUILT**

**COLGANTES**

LED SMD AC 100-305V 50-60Hz

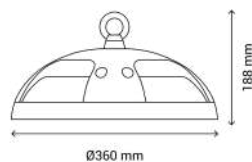

Material

<b>100757</b>	100 W	12000 lm	4000 K	Negro RAL 9005
<b>101182</b>	150 W	20050 lm	4000 K	Negro RAL 9005

T-10V  
 -5~+40°C  
 IP 55 IK 07  
 CRI180 90° 20000 50000 h

Accesorios / Accessories

50624 - Óptica 50°



50625 - Sensor



50626 - Bracket



901000 - Elevador de campanas



REF/100757

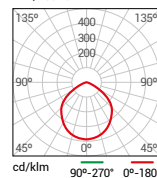

REF/101182

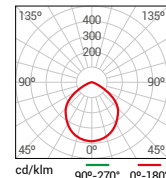

# CANADIAN



## CANADIAN

LED SMD AC 220-240V 50-60Hz

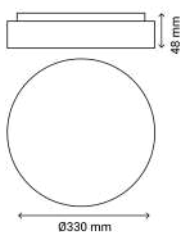

Material **ABS**

**100764** 24 W 2500 lm 4000 K

Blanco RAL 9003

## PLAFONES

## CANADIAN

LED SMD AC 220-240V 50-60Hz

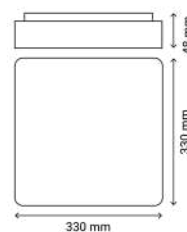

Material **ABS**

**100765** 24 W 2500 lm 4000 K

Blanco RAL 9003

## PLAFONES

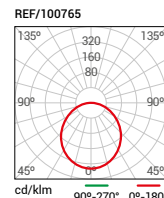
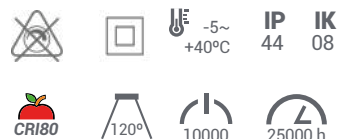
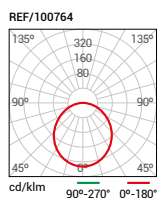





# SUKO



## SUKO

PLAFONES

LED COB AC 100-240V 50-60Hz

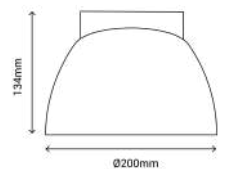

Material **ABS**

**200766**    7 W    450 lm    3000 K    Blanco RAL 9003



REF/101182

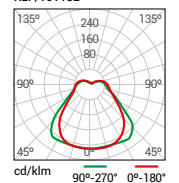







# ARIS INMA OKO







### ARIS

### EMPOTRABLES

LED SMD AC 100-240V 50-60Hz



Material

<b>400000</b>	2 W	80 lm	3000 K	Blanco RAL 9003
<b>400103</b>	2 W	80 lm	3000 K	Aluminio

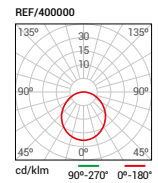

### INMA

### EMPOTRABLES

LED SMD AC 100-240V 50-60Hz

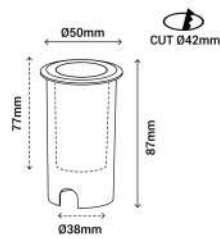

Material

<b>400008</b>	2 W	90 lm	3000 K	Blanco RAL 9003
<b>400104</b>	2 W	90 lm	3000 K	Aluminio

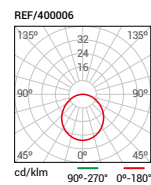

### INMA

### EMPOTRABLES

LED SMD AC 100-240V 50-60Hz

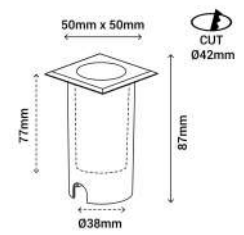

Material

<b>400006</b>	2 W	90 lm	3000 K	Blanco RAL 9003
<b>400105</b>	2 W	90 lm	3000 K	Aluminio

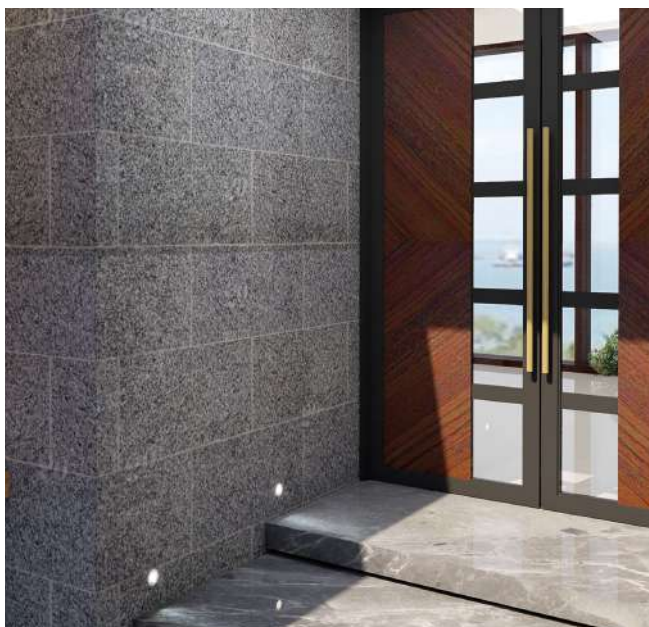
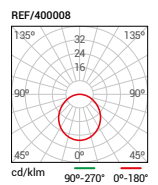

### OKO

### EMPOTRABLES

LED SMD AC 100-240V 50-60Hz



Material

<b>400005</b>	2 W	80 lm	3000 K	Blanco RAL 9003
<b>400106</b>	2 W	80 lm	3000 K	Aluminio

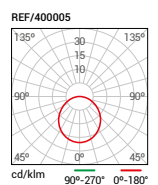

**COBSOIL**





**COBSOIL**

**EMPOTRABLES SUELO**

LED SMD DC24V

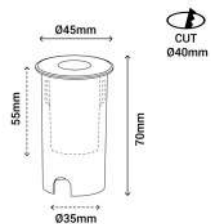

Material

400213	1,5 W	130 lm	2700 K	15°	Acero 316
400214	1,5 W	130 lm	2700 K	25°	Acero 316
400215	1,5 W	130 lm	2700 K	40°	Acero 316
400216	1,5 W	130 lm	2700 K	*OPAL.	Acero 316
400251	1,5 W	130 lm	2700 K	15°	Bronce
400252	1,5 W	130 lm	2700 K	25°	Bronce
400253	1,5 W	130 lm	2700 K	40°	Bronce
400254	1,5 W	130 lm	2700 K	*OPAL.	Bronce
400239	1,5 W	130 lm	2700 K	15°	Negro RAL 9005
400240	1,5 W	130 lm	2700 K	25°	Negro RAL 9005
400241	1,5 W	130 lm	2700 K	40°	Negro RAL 9005
400242	1,5 W	130 lm	2700 K	*OPAL.	Negro RAL 9005
400233	1,5 W	130 lm	4000 K	15°	Acero 316
400234	1,5 W	130 lm	4000 K	25°	Acero 316
400235	1,5 W	130 lm	4000 K	40°	Acero 316
400236	1,5 W	130 lm	4000 K	*OPAL.	Acero 316
400257	1,5 W	130 lm	4000 K	15°	Bronce
400258	1,5 W	130 lm	4000 K	25°	Bronce
400259	1,5 W	130 lm	4000 K	40°	Bronce
400269	1,5 W	130 lm	4000 K	*OPAL.	Bronce
400245	1,5 W	130 lm	4000 K	15°	Negro RAL 9005
400246	1,5 W	130 lm	4000 K	25°	Negro RAL 9005
400247	1,5 W	130 lm	4000 K	40°	Negro RAL 9005
400248	1,5 W	130 lm	4000 K	*OPAL.	Negro RAL 9005

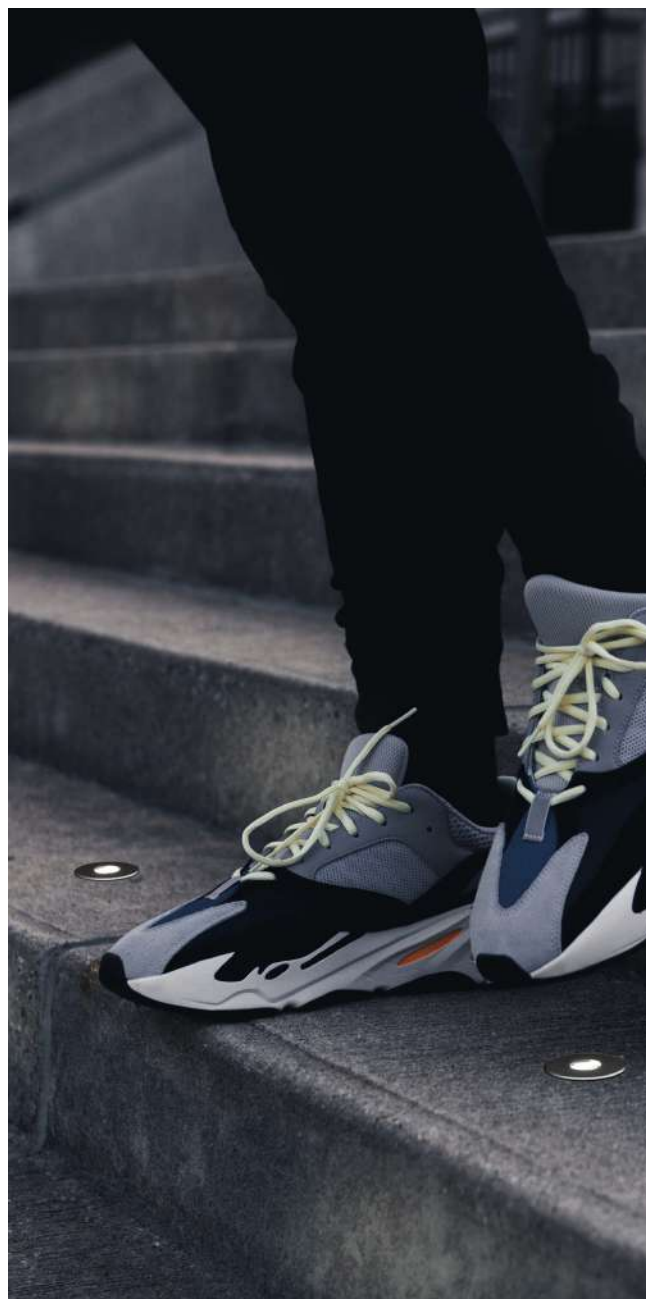

REF/400213

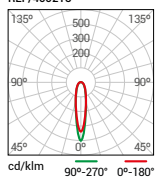

Accesorios / Accessories



Pag.77

3 ACABADOS  
3 FINISHES



\*LENTE OPALESCENTE Reduce reflejos  
OPALESCECENT LENS - anti-glare effect



LENTE TRANSLÚCIDA 15° 25° 40°  
TRANSLUCENT LENS 15° 25° 40°



**COBSOIL**





LED SMD DC 24V



**EMPOTRABLES SUELO**



Material 

400218	7 W	600lm	3000 K	15°	Acero 316
400217	7 W	600lm	3000 K	25°	Acero 316
400281	7 W	600lm	3000 K	40°	Acero 316
400282	7 W	600lm	3000 K	*OPAL.	Acero 316
400415	7 W	600lm	3000 K	15°	Bronce
400416	7 W	600lm	3000 K	25°	Bronce
400417	7 W	600lm	3000 K	40°	Bronce
400418	7 W	600lm	3000 K	*OPAL.	Bronce
400291	7 W	600lm	3000 K	15°	Negro RAL 9005
400292	7 W	600lm	3000 K	25°	Negro RAL 9005
400293	7 W	600lm	3000 K	40°	Negro RAL 9005
400294	7 W	600lm	3000 K	*OPAL.	Negro RAL 9005
400288	7 W	600lm	4000 K	15°	Acero 316
400289	7 W	600lm	4000 K	25°	Acero 316
400290	7 W	600lm	4000 K	40°	Acero 316
400287	7 W	600lm	4000 K	*OPAL.	Acero 316
400421	7 W	600lm	4000 K	15°	Bronce
400422	7 W	600lm	4000 K	25°	Bronce
400423	7 W	600lm	4000 K	40°	Bronce
400424	7 W	600lm	4000 K	*OPAL.	Bronce
400297	7 W	600lm	4000 K	15°	Negro RAL 9005
400298	7 W	600lm	4000 K	25°	Negro RAL 9005
400299	7 W	600lm	4000 K	40°	Negro RAL 9005
400400	7 W	600lm	4000 K	*OPAL.	Negro RAL 9005



Accesorios / Accessories

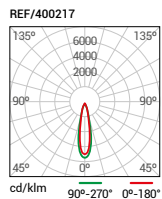

**COBSOIL**





LED COB AC 220-240V 50-60 Hz





**EMPOTRABLES SUELO**



Material 

111058	15 W	1320 lm	3000 K	Acero 316
--------	------	---------	--------	-----------





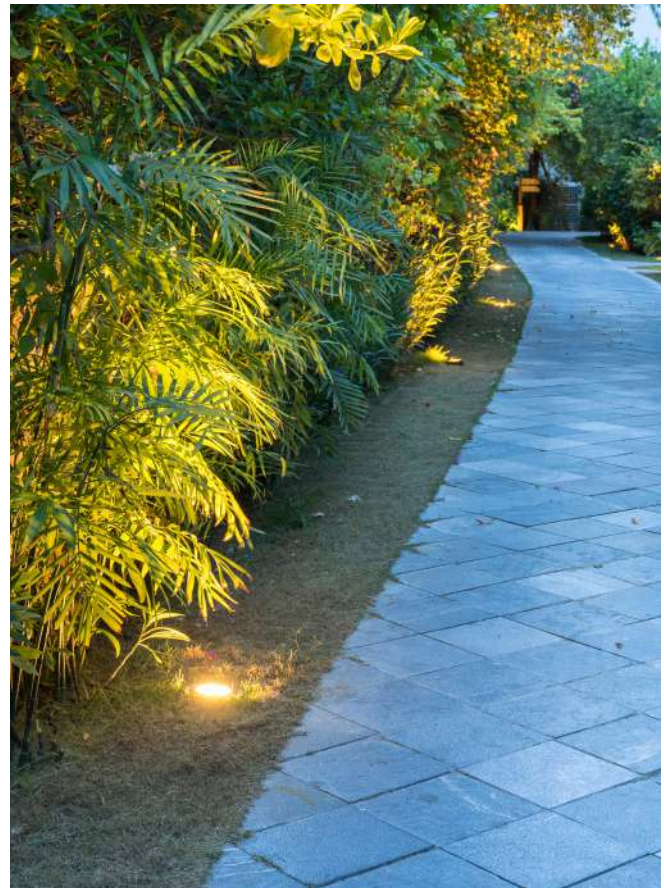
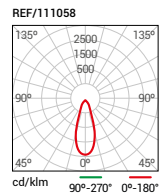

# AQUARUM

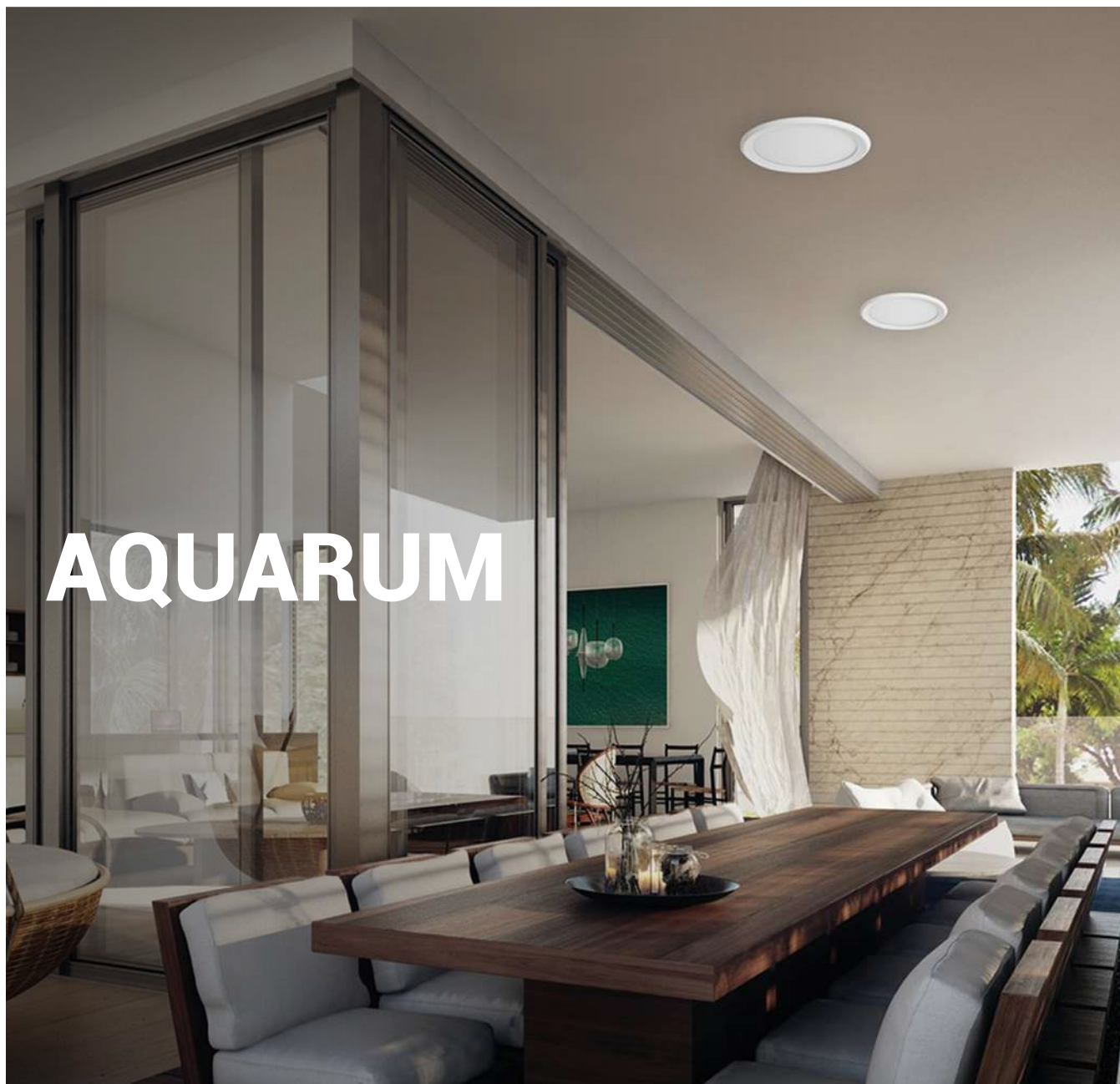
## AQUARUM

## EMPOTRABLES

LED SMD AC 85-265V



**940540**    20 W    1400 lm    4000 K    Blanco RAL 9003



REF/940540

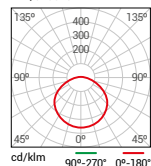





# DOUCHE

## DOUCHE

EMPOTRABLES

LED SMD AC 200-240V 50-60Hz



Material

**112050** 7 W 560 lm 4000 K

Blanco RAL 9003

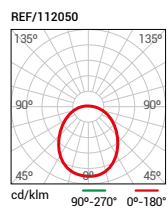
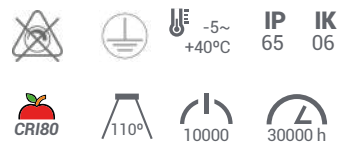

## DOUCHE

EMPOTRABLES

LED SMD AC 100-240V 50-60Hz



Material

**112052** 7 W 560 lm 4000 K

Blanco RAL 9003

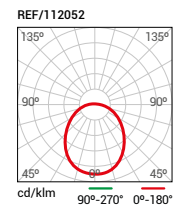
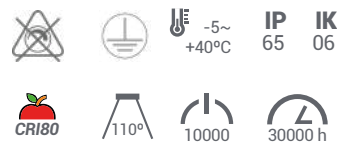



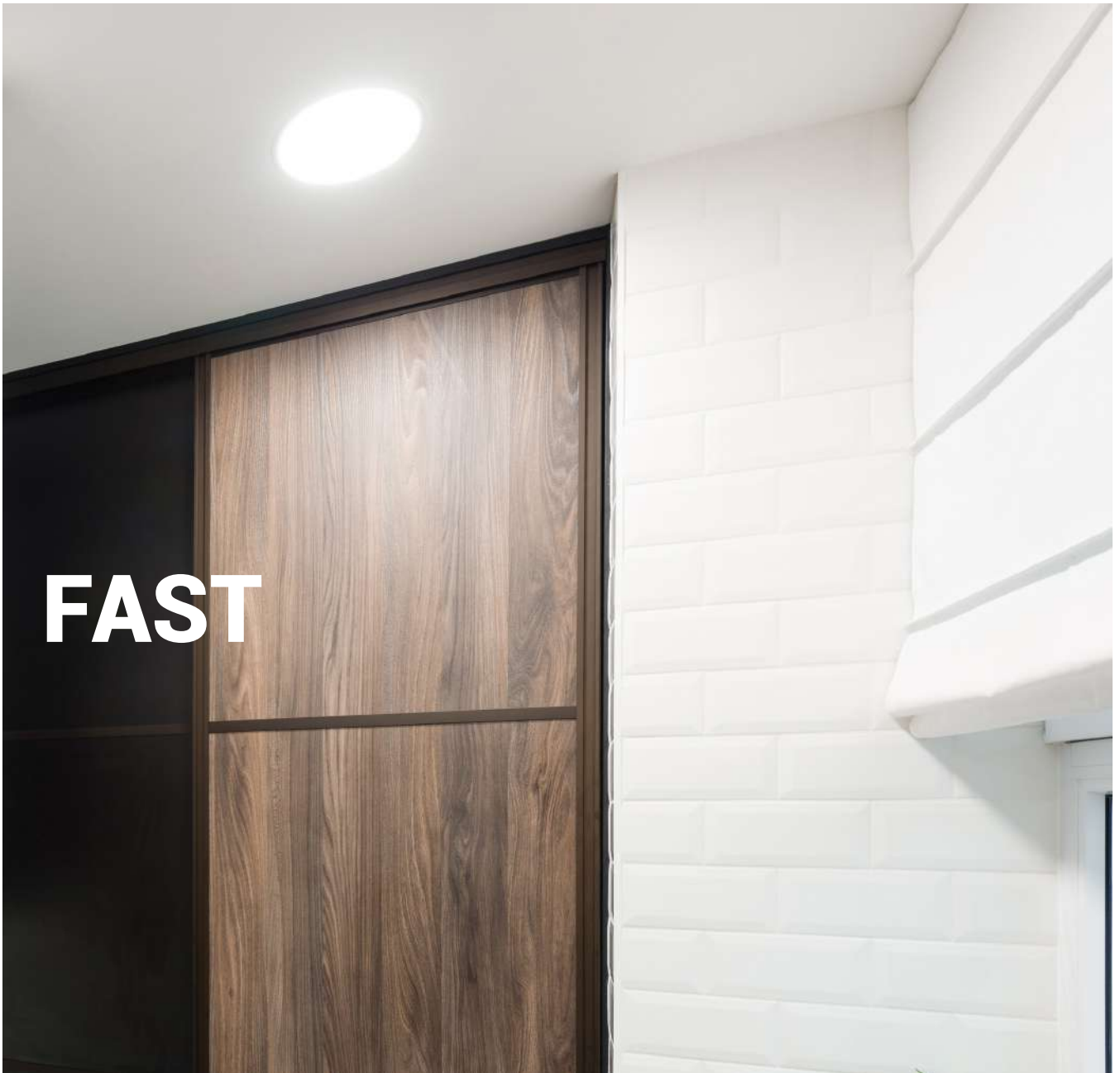

FAST

**FAST**

*EMPOTRABLES*

LED SMD AC 220-240V 50-60Hz

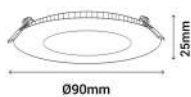

CUT Ø75mm

Material

<b>365093</b>	4 W	250 lm	3000 K	Blanco RAL 9003
<b>365095</b>	4 W	300 lm	4000 K	Blanco RAL 9003

**FAST**

*EMPOTRABLES*

LED SMD AC 220-240V 50-60Hz

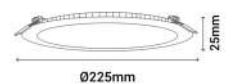

CUT Ø200mm

Material

<b>365094</b>	18 W	1500 lm	3000 K	Blanco RAL 9003
<b>365096</b>	18 W	1550 lm	4000 K	Blanco RAL 9003

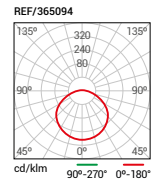
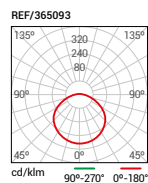











**BELY**





**BELY**

**BAÑADORES**

LED COB AC 100-240 V 50-60 Hz

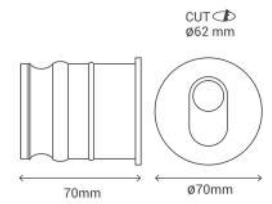

Material

<b>400090</b>	3 W	120 lm	3000 K	Blanco RAL 9003
<b>400110</b>	3 W	120 lm	3000 K	Gris antracita RAL 7012
<b>400112</b>	3 W	120 lm	3000 K	Marrón RAL 8025
<b>400089</b>	3 W	120 lm	4000 K	Blanco RAL 9003
<b>400111</b>	3 W	120 lm	4000 K	Gris antracita RAL 7012
<b>400113</b>	3 W	120 lm	4000 K	Marrón RAL 8025



-20~  
+50°C

IP 54 IK 06



15000

25000 h

REF/400090

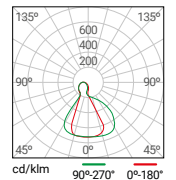

**BELY**

**BAÑADORES**

LED COB AC 100-240 V 50-60 Hz

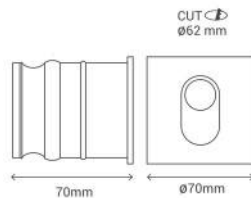

Material

<b>400114</b>	3 W	120 lm	3000 K	Blanco RAL 9003
<b>400116</b>	3 W	120 lm	3000 K	Gris antracita RAL 7012
<b>400118</b>	3 W	120 lm	3000 K	Marrón RAL 8025
<b>400115</b>	3 W	120 lm	4000 K	Blanco RAL 9003
<b>400117</b>	3 W	120 lm	4000 K	Gris antracita RAL 7012
<b>400119</b>	3 W	120 lm	4000 K	Marrón RAL 8025



-20~  
+50°C

IP 54 IK 06



15000

25000 h

REF/400114

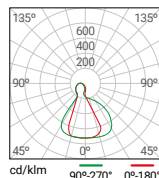



# KAMAL

## KAMAL

## BAÑADORES

LED SMD AC 220-240V 50-60 Hz

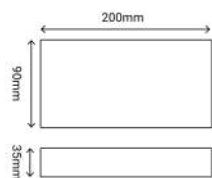







Material 

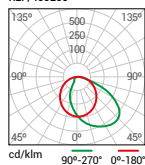



<b>113192</b>	8 W	480 lm	4000 K	Negro RAL 9005
<b>400200</b>	8 W	480 lm	4000 K	Gris antracita RAL 7012
<b>400201</b>	8 W	480 lm	4000 K	Marrón RAL 8025



REF/400200





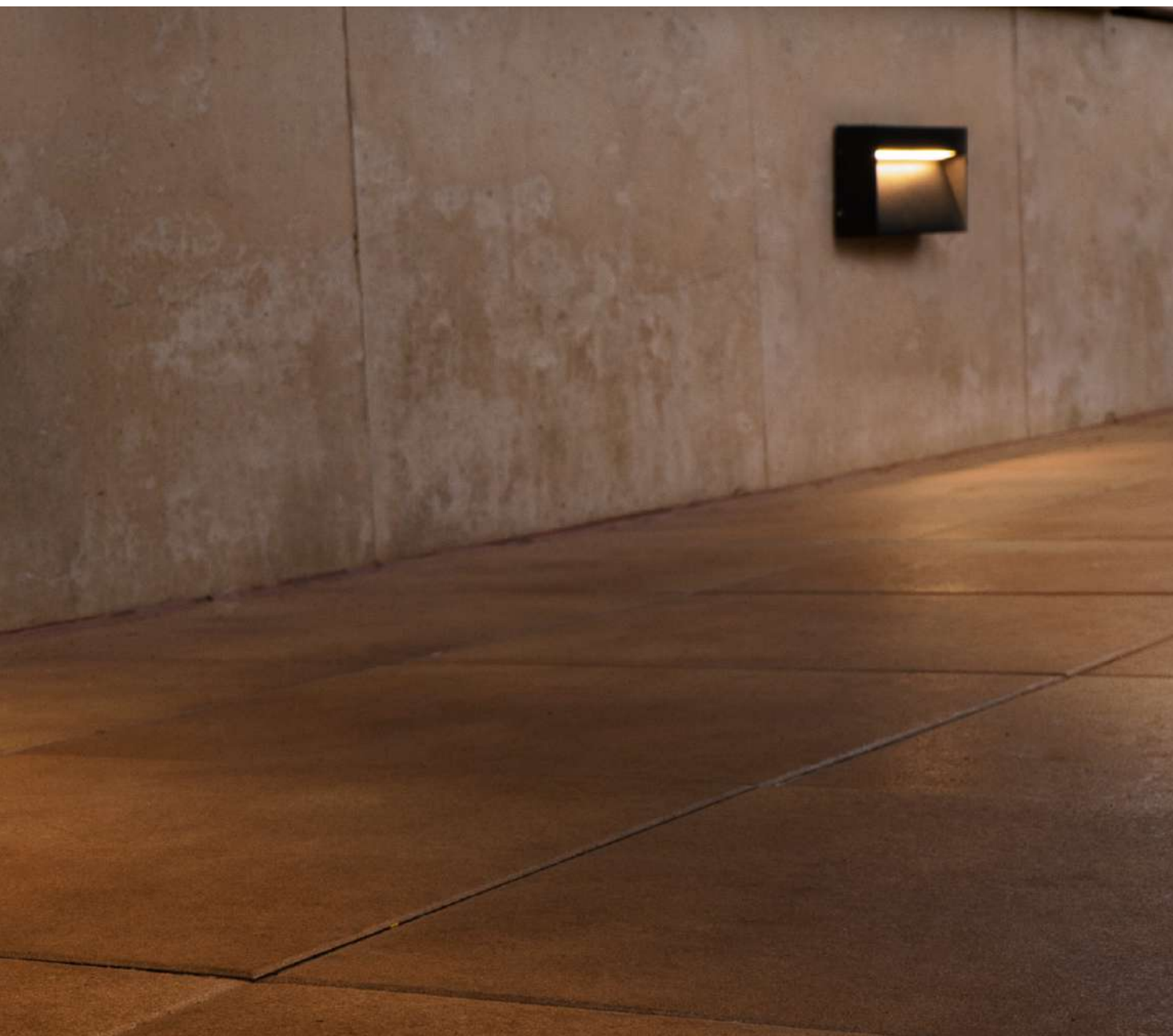

**KAMAL**

**BAÑADORES**

LED SMD AC 220-240V 50-60 Hz

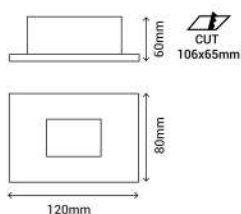

Material

<b>250900</b>	1,5 W	110 lm	3000 K	Blanco RAL 9003
<b>250901</b>	1,5 W	110 lm	4000 K	Blanco RAL 9003

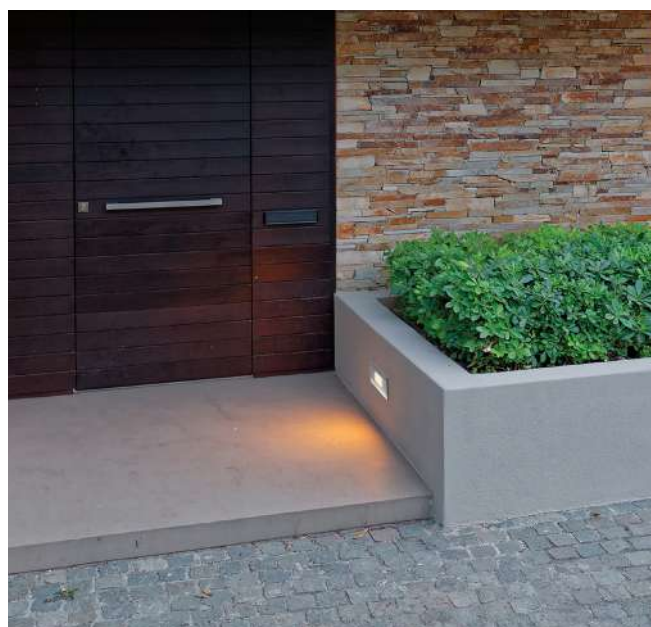
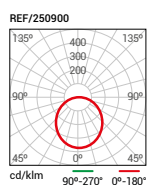





**SIA**



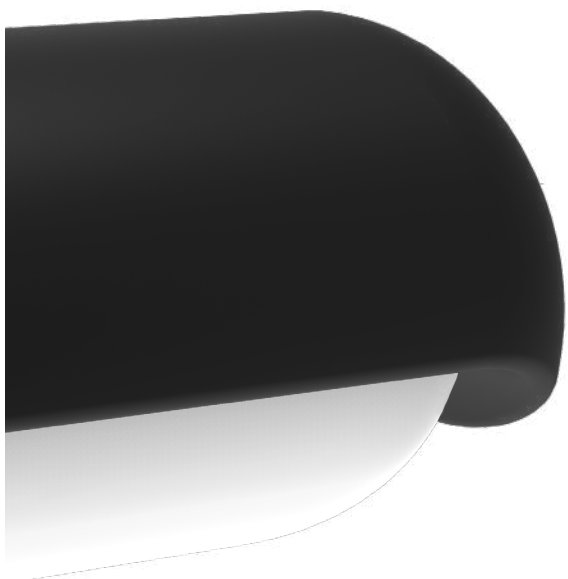

**SIA**

**BAÑADORES**

LED SMD AC 100-240V 50-60Hz

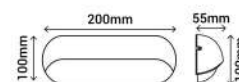

Material **ABS**

<b>200775</b>	13 W	1050 lm	3000 K	Negro RAL 9005
<b>200780</b>	13 W	1050 lm	4000 K	Negro RAL 9005

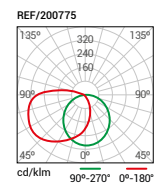



A photograph of a brick building facade at dusk. The building is constructed of red brick and features a series of windows with illuminated sills. The light from the sills creates a warm, golden glow on the brickwork. In the foreground, there is a concrete base or wall. The word "PENN" is overlaid in white, bold, sans-serif font on the left side of the image.

**PENN**



**PENN**

**BAÑADORES**

LED SMD DC24V



Material

<b>100795</b>	18 W	1150 lm	2700 K	Aluminio
<b>102796</b>	18 W	1350 lm	4000 K	Aluminio
<b>102795</b>	18 W		RGB	Aluminio

-5~+40°C **IP 66** **IK 06** **CRI90** 60° 10000 30000 h **RGB**

REF/102796

Accesorios / Accessories

Pag.77

- 10080 - Conector hembra
- 10081 - Tapón hembra
- 10084 - Fijación 37mm
- 10083 - Fijación 65mm



**PENN**

**BAÑADORES**

LED SMD DC24V 50-60Hz



Material

<b>102798</b>	36 W	2750 lm	2700 K	Aluminio
<b>102799</b>	36 W	2250 lm	4000 K	Aluminio
<b>102797</b>	36 W		RGB	Aluminio

-5~+40°C **IP 66** **IK 06** **CRI90** 60° 10000 30000 h **RGB**

REF/102799

Accesorios / Accessories

Pag.77

- 10080 - Conector hembra
- 10081 - Tapón hembra
- 10084 - Fijación 37mm
- 10083 - Fijación 65mm











**THIN**







**THIN**

LED SMD AC 100-240V 50-60Hz

**PINCHOS / PROYECTOR**

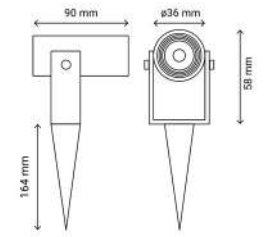

Material 

<b>111462</b>	3 W	130 lm	2700 K	Negro RAL 9005
<b>111050</b>	3 W	130 lm	3000 K	Negro RAL 9005
<b>111463</b>	3 W	130 lm	4000 K	Negro RAL 9005

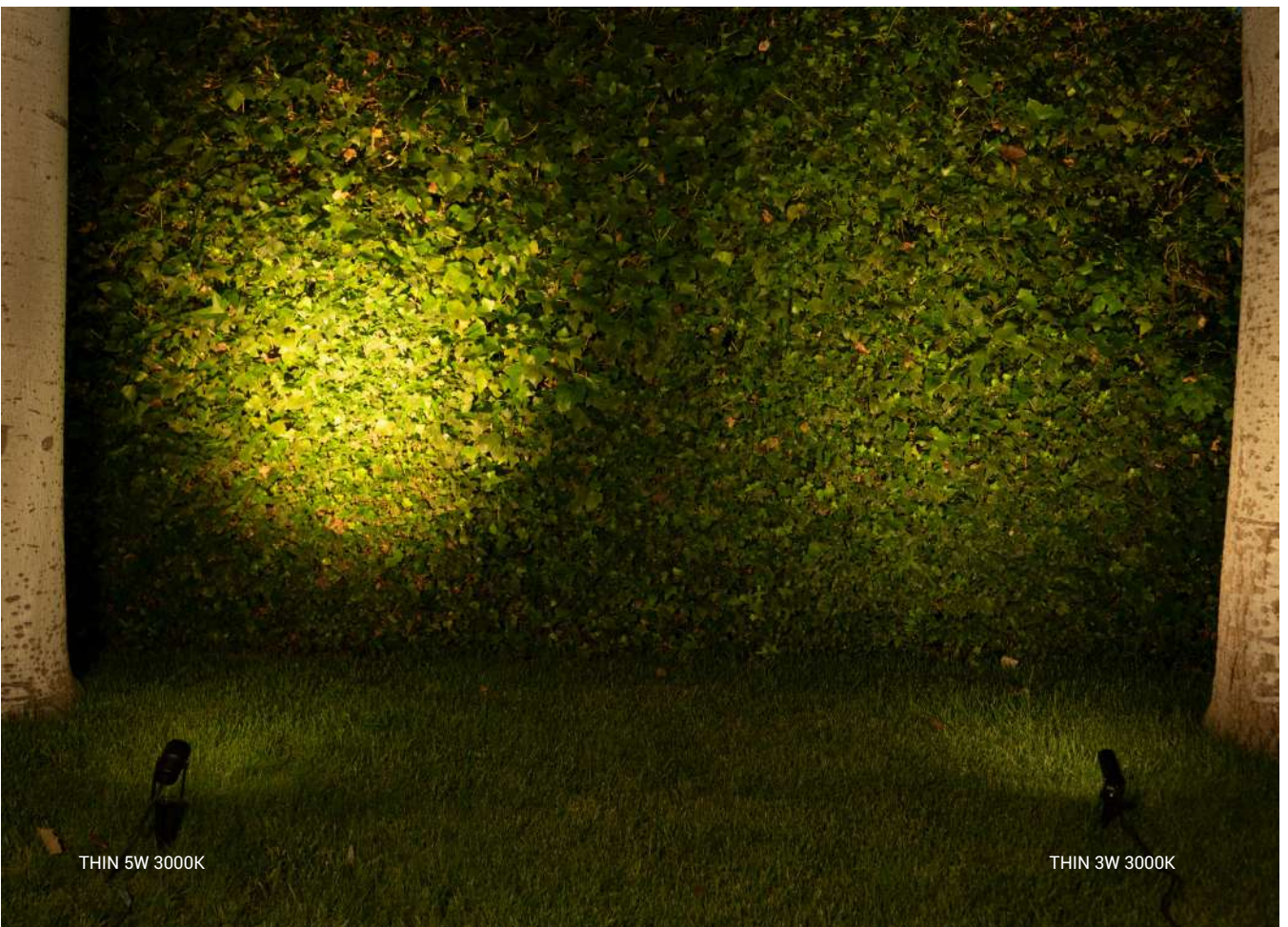
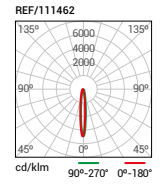

THIN 5W 3000K

THIN 3W 3000K

**THIN**

LED SMD AC 220V 50-60Hz



**PINCHOS / PROYECTOR**

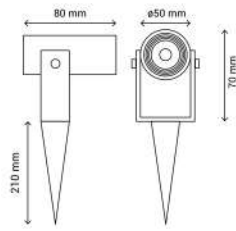

Material

<b>400301</b>	5 W	360 lm	3000 K	15°	Negro RAL 9005
<b>400300</b>	5 W	360 lm	3000 K	24°	Negro RAL 9005
<b>400302</b>	5 W	360 lm	3000 K	38°	Negro RAL 9005
<b>400304</b>	5 W	360 lm	4000 K	15°	Negro RAL 9005
<b>400303</b>	5 W	360 lm	4000 K	24°	Negro RAL 9005
<b>400305</b>	5 W	360 lm	4000 K	38°	Negro RAL 9005

**THIN**

LED SMD AC 220V 50-60Hz



**PINCHOS / PROYECTOR**

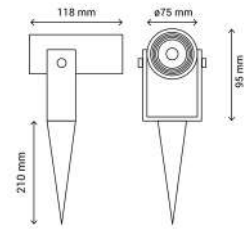

Material

<b>400260</b>	15 W	850 lm	3000 K	15°	Negro RAL 9005
<b>400208</b>	15 W	850 lm	3000 K	24°	Negro RAL 9005
<b>400261</b>	15 W	850 lm	3000 K	38°	Negro RAL 9005
<b>400262</b>	15 W	850 lm	4000 K	15°	Negro RAL 9005
<b>400263</b>	15 W	850 lm	4000 K	24°	Negro RAL 9005
<b>400264</b>	15 W	850 lm	4000 K	38°	Negro RAL 9005

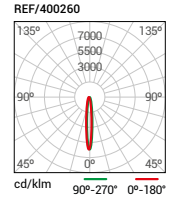
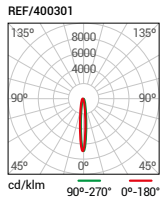

Accesorios / Accessories  
36991 - Visera



Accesorios / Accessories  
36990 - Visera



**COBMIST THIN**

LED COB AC 220-240V 50-60Hz



**PINCHOS / PROYECTOR**

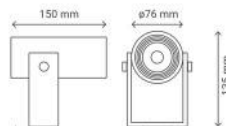

Material

<b>111051</b>	10 W	910 lm	3000 K	Negro RAL 9005
---------------	------	--------	--------	----------------

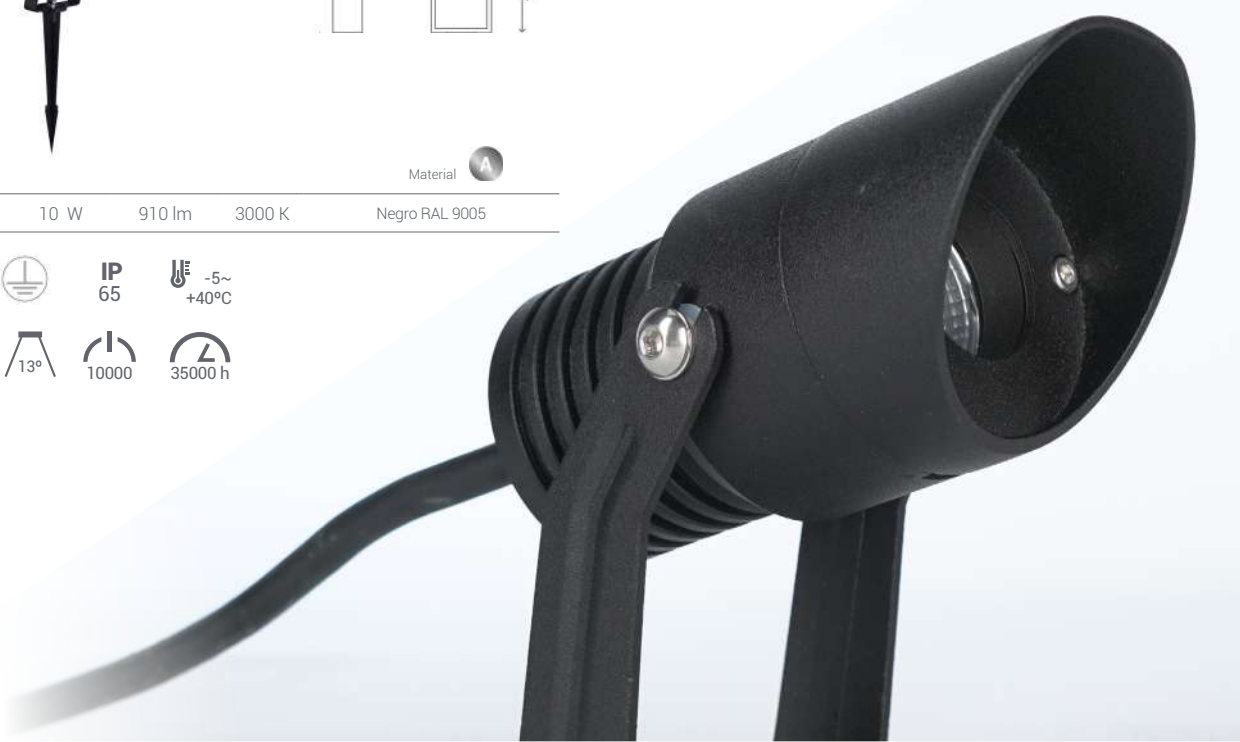



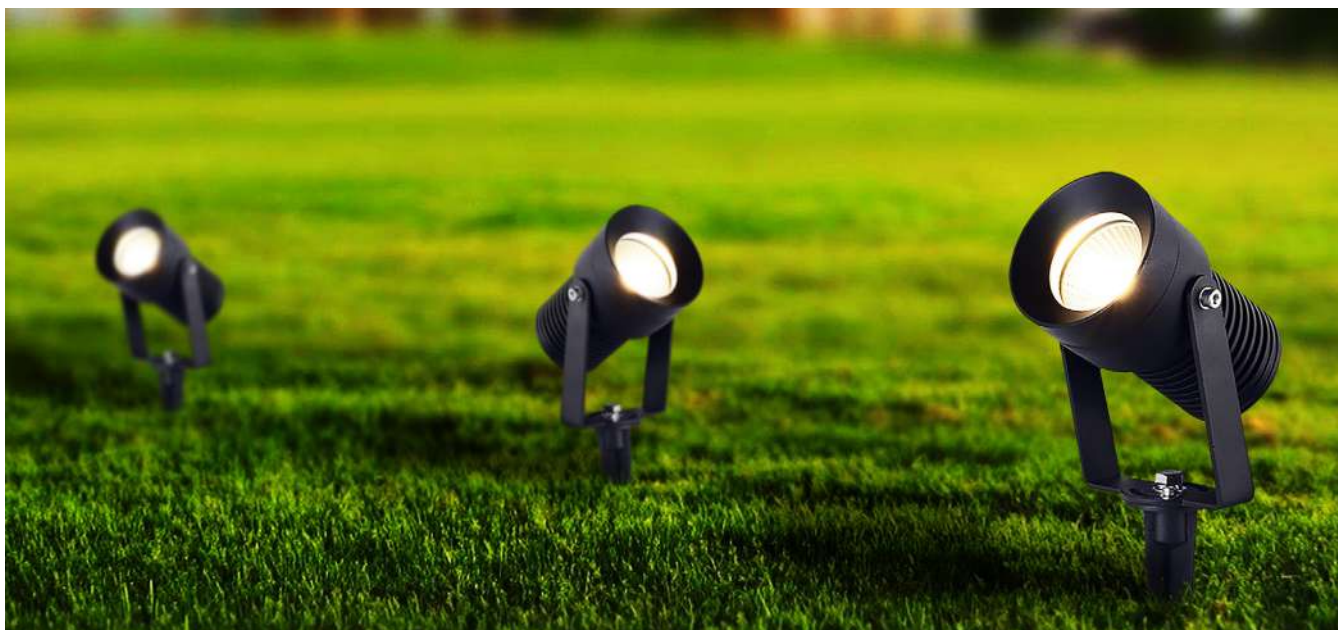





**YUKA**



**YUKA ESTILO**

**PINCHOS / PROYECTOR**

AC Max. 250V 50-60Hz

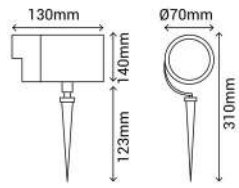

Material

400091

1 xGU10

Negro RAL 9005



**YUKA**

**PINCHOS / PROYECTOR**

AC Max. 250V 50-60Hz

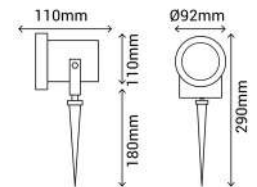

Material

112308

1 xGU10

Negro RAL 9005











**HELIO**





**HELIO** EXTERIOR SOLAR

LED SMD 3.7V 2200mAh

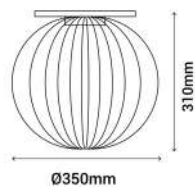

Material

**400076** 3 W 450 lm 3000 K Negro RAL 9005

**HELIO** EXTERIOR SOLAR

LED SMD 3.7V 2200mAh

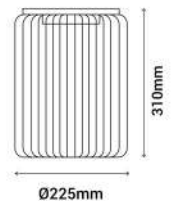

Material

**400052** 3 W 450 lm 3000 K Negro RAL 9005



# NEKO



## NEKO

## EXTERIOR SOLAR

LED SMD 3.7V 1200mAh

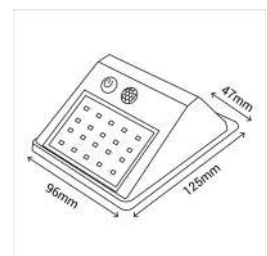

Material **ABS**

<b>112262</b>	3 W	320 lm	6000 K	Negro RAL 9005
---------------	-----	--------	--------	----------------







**BIRD**

EXTERIOR SOLAR

LED SMD 3.7V 1200mAh

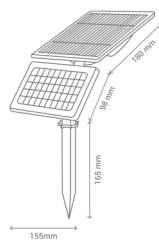

Material **ABS**

<b>200582</b>	10 W	300 lm	6000 K	Negro RAL 9005
---------------	------	--------	--------	----------------

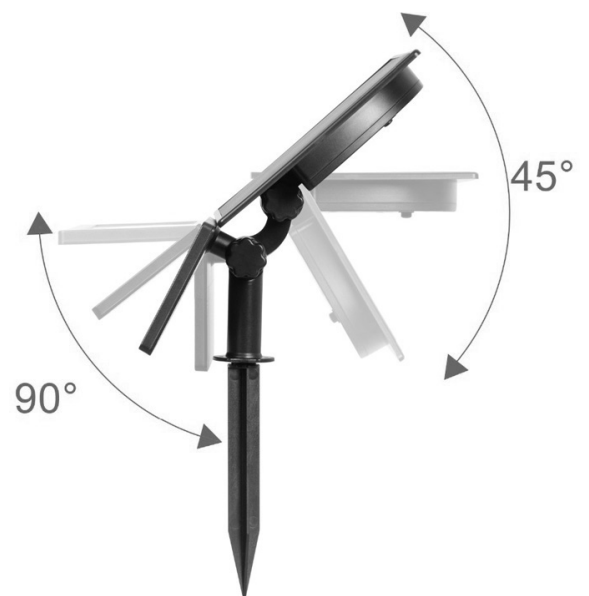





**KIPPER**



**KIPPER**

EXTERIOR SOLAR

LED SMD 2.7V 3000mAh

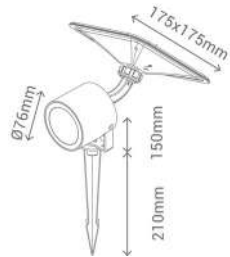

Material ABS

**112432**    5 W    210 lm    4000 K    Negro RAL 9005



$\text{°C}$  -20~  
+50

IP 65    IK 06



**12h**  
  
**ION-litium**



**KIPPER**

EXTERIOR SOLAR

LED SMD 3.2V 500mAh

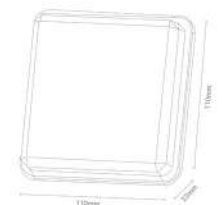

Material ABS

**200597**    1,5 W    120 lm    6000 K    Azul / Negro RAL 9005



$\text{°C}$  -20~  
+50

IP 68    IK 06



**12h**  
  
**ION-litium**

# DRIVER



### DRIVER MEAN WELL IP20

24V

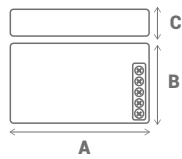

Ref	W	input	output
24125	25W	100-240V AC	24V DC 1,1A
24135	35W	100-240V AC	24V DC 1,5A
24175	75W	100-240V AC	24V DC 3,2A
24010	100W	100-240V AC	24V DC 4,5A
24150	150W	100-240V AC	24V DC 6,5A
24200	200W	100-240V AC	24V DC 8,4A
24250	250W	100-240V AC	24V DC 10A

Size (mm)

A	B	C
99	82	35
99	97	36
159	97	38
159	97	38
200	97	38
215	115	30
215	115	30

### DRIVER MEAN WELL IP67

24V

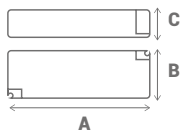

Ref	W	input	output
24020	25W	100-240V AC	24V DC 1,1A
24035	35W	100-240V AC	24V DC 1,5A
24060	60W	100-240V AC	24V DC 3,2A
24100	100W	100-240V AC	24V DC 4,5A
24350	150W	100-240V AC	24V DC 4,5A

Size (mm)

A	B	C
118	35	26
148	40	30
163	43	32
190	52	37
191	63	38

### DRIVER SULION IP20

24V

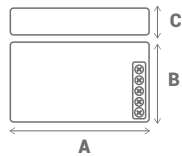

Ref	W	input	output
24730	25W	100-240V AC	24V DC 1,1A
24740	40W	100-240V AC	24V DC 1,5A
24780	80W	100-240V AC	24V DC 3,2A
24710	100W	100-240V AC	24V DC 4,5A
24715	150W	100-240V AC	24V DC 6,5A
24720	200W	100-240V AC	24V DC 8,4A
24725	250W	100-240V AC	24V DC 10A

Size (mm)

A	B	C
99	82	35
99	97	36
159	97	38
159	97	38
200	97	38
215	115	30
215	115	30

### DRIVER SULION IP67

24V

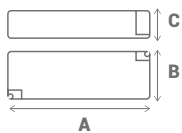

Ref	W	input	output
24630	25W	100-240V AC	24V DC 1,1A
24640	40W	100-240V AC	24V DC 1,5A
24680	80W	100-240V AC	24V DC 3,2A
24610	100W	100-240V AC	24V DC 4,5A
24615	150W	100-240V AC	24V DC 6,5A
24620	200W	100-240V AC	24V DC 8,4A
24625	250W	100-240V AC	24V DC 10A

Size (mm)

A	B	C
118	35	26
148	40	30
163	43	32
190	52	37
191	63	38
215	74	40
215	74	40

# PÁGINA EXPLICATIVA

Help page  
Page explicative  
Página explicativa

SÛLION



**PRODUCTO**  
PRODUCT  
PRODUIT  
PRODUCTO

**REFERENCIA**  
REFERENCE  
RÉFÉRENCE  
REFERÊNCIA

**DATOS TÉCNICOS**  
TECHNICAL DATA  
DONNÉES TECHNIQUES  
DADOS TÉCNICOS

**ACCESORIOS**  
ACCESSORIES  
ACCESSOIRES  
ACESSÓRIOS



**NEKO**

EXTERIOR SOLAR

LED SMD 3.7V 1200mAh



Material **ABS**

112262 3W 320 lm 6000 K Negro RAL 9005





EXTERIOR | 2021

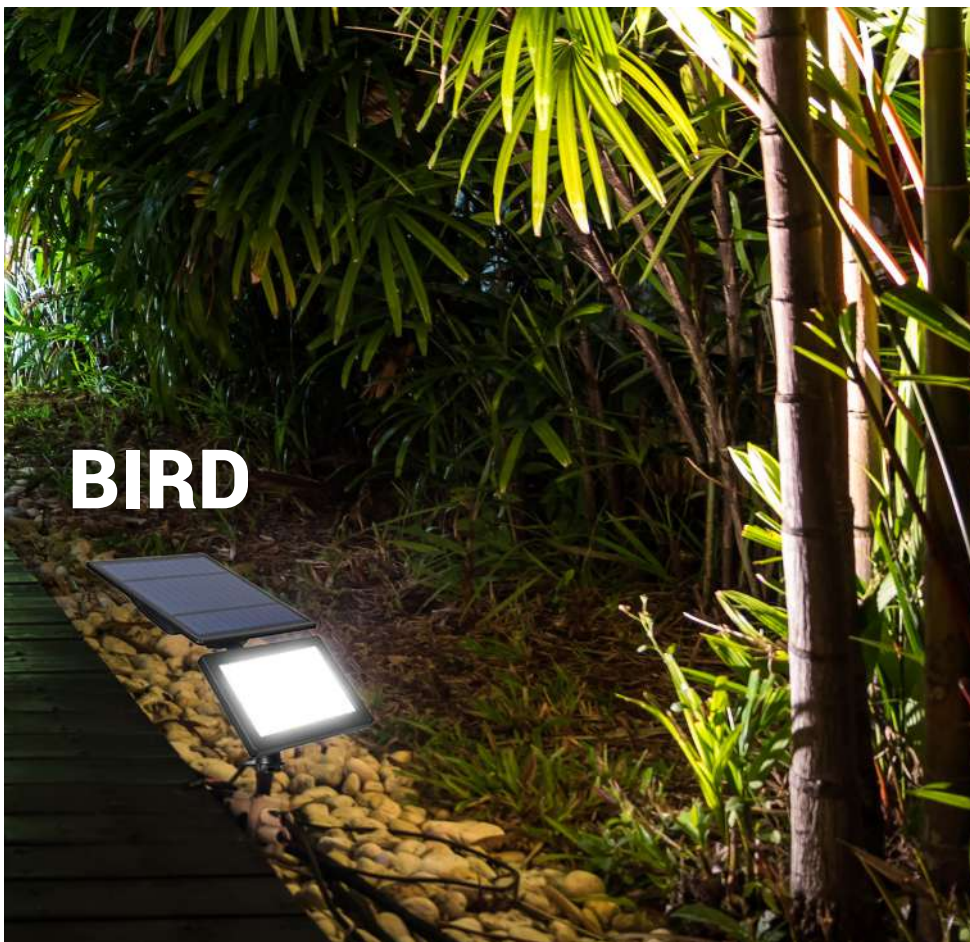

**BIRD**

**BIRD** EXTERIOR SOLAR

LED SMD 3.7V 1200mAh

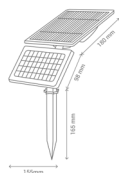

Material **ABS**  
Negro RAL 9005

**200582** 10 W 300 lm 6000 K

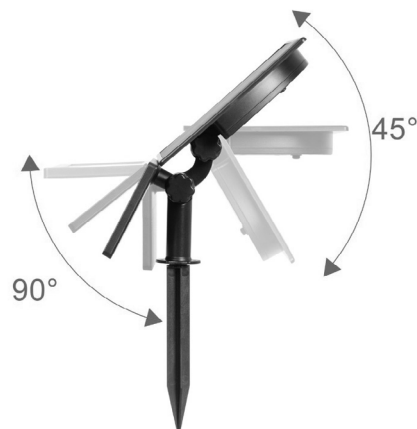

			<b>IP 65</b>	<b>IK 6</b>		<b>12h</b> ION-litium

**SECCIÓN**  
SECTION  
SECTION  
SEÇÃO

**TIPOLOGÍA**  
TIPOLOGY  
TYPOLOGIE  
TIPOLOGIA



**DIMENSIONES**  
SIZE  
DIMENSIONS  
DIMENSÕES























**MATERIAL**  
MATERIAL  
MATÉRIEL  
MATERIAL

**PLUS PRODUCTO**  
PLUS PRODUIT  
PLUS PRODUIT  
PLUS PRODUTO

# ICONOS

íconos | icônes | ícones







	ES	EN	FR	PT
	Producto nuevo	New product	Nouveau produit	Novo produto
	Tensión	Voltage	Tension	Voltagem
	Temperatura trabajo	Work temperature	Température travaille	Temperatura trabalho
	Factor de potencia	Power factor	Facteur de puissance	Fator de potência
	Clase I	Class I	Classe électrique I	Classe I
	Clase II	Class II	Classe électrique II	Classe II
	Grado de protección IP	IP protection degree	Degré de protection IP	Nível de proteção IP
	Bombilla incluida	Bulb included	Ampoule incluse	Lâmpada incluída
	Bombilla no incluida	Bulb not included	Ampoule non incluse	Não incluída
	Horas de vida	Lifetime	Heures de vie	Horas de vida
	Número de encendidos	Number of ignitions	Nombre de démarrages	Número de ascendidos
	Peso	Weight	Poids	Peso
	Regulación en intensidad	Adjustable intensity	Intensité ajustable	Regulação em intensidade
	Regulable en intensidad	Adjustable intensity	Intensité ajustable	Ajustável em intensidade
	Regulable en intensidad	Adjustable intensity	Intensité ajustable	Ajustável em intensidade
	Regulación en temperatura de color	Adjustable colour intensity	Température de couleur ajustable	Regulação da temperatura de cor
	3 temperaturas de color	3 Colour temperature	3 Température de couleur	3 Temperatura de cor
	Luz colores RGB	RGB colors Light	Lumière couleurs RGB	Luz cores RGB
	Ángulo de apertura	Opening angle	Angle d'ouverture	Ângulo de abertura
	Índice de reproducción cromática	Colour rendering index	Indice de rendu des couleurs	Índice reprodução de cor
	Producto doméstico	Home automation product	Produit domotique	Produto domotico
	Bluetooth APP	Bluetooth APP	Bluetooth APP	Bluetooth APP

	ES	EN	FR	PT
	APP	APP	APP	APP
	Altavoz	Speaker	Orateur	Alto falante
	Madera natural	Natural Wood	Bois Naturel	Madeira natural
	Longitud de cable	Cable length	Longueur de câble	Comprimento do cabo
	Longitud de cable con enchufe	Cable length with plug	Longueur de câble avec plug	Comprimento do cabo com plugue
	Con interruptor	with swicht	avec interrupteur	com interruptor
	Con mando	with remote control	avec télécommande	con controle remoto
	Orientable	Tilt herad	Tête pivotante	Ajustável
	Oscilante	Oscillating	Oscillante	Oscilante
	Salida de luz bilateral	Bidirectional light	Lumière bidirectionnelle	Luz bidirecional
	Salida de luz bilateral ajustable	Bidirectional light adjustable	Lumière bidirectionnelle ajustable	Luz bidirecional ajustável
	Luz uindirecta	Indirect light	Lumière indirect	Luz indireta
	Extensible	Extensible	Extensible	Extensível
	Pintable	Paintable	Peinture	Pintable
	Con toma USB	with USB connexion	Avec USB connexion	avec connexion USB
	Modo noche	Night mode	Mode nuit	Modo noturno
	Madera natural	Natural wood	Bois Naturel	Madeira natural
	Autonomía de batería	Battery autonomy	Autonomie de la batterie	Autonomia da bateria
	Sensor Luz	Sensor light	Sensor lumière	Sensor luz
	Sensor PIR	PIR Sensor	PIR Sensor	Sensor PIR
	Sobremesa	Table lamp	Lampes	Candeeiros de mesa
	Pié	Floor lamp	Lampadaires	Candeeiros de pé



# MATERIAL

Material | Matériel | Material

	ES	EN	FR	PT
	Colgante	Pendant lamp	Luminaire de suspension	Luminária de suspensão
	Aplique	Wall lamp	Appliquer	Aplique
	Plafón	Ceiling lamp	Plafond	Lâmpada de teto
	Empotrable	Recessed	À encastrer	Encastramento
	Baliza	Post lamps	Bornes	Candeieiro de pé
	Solar	Solar	Solaire	Solar
	Bombilla	Light bulb	Ampoule	Lâmpada



**ALUMINIO** | ALUMINIUM | ALUMINIUM | ALUMINIO



**CRISTAL** | GLASS | CRISTAL | VIDRIO



**ACRILICO** | ACRYLYC | ACRYLIQUE | ACRÍLICO



**ABS** | ABS | ABS | ABS



**SILICONA** | SILICONE | SILICONE | SILICONA



**MADERA** | WOOD | BOIS | MADEIRA



**BAMBU** | BAMBOO | BAMBOO | BAMBOO



**RATAN** | RATTAN | RATTAN | RATAN



**CUERDA** | CORD | CHAÎNE | FRAGMENTO



**TEXTIL** | TEXTILE | TEXTILE | TÊXTIL



**YESO** | GYPSUM | PLÂTRE | GRESSO



**CEMENTO** | CONCRETE | BÉTON | CONCRETO

# ÍNDICE INDEX

REF	Nombre	tipo	LED	Casquillo	página
10080	ACCESORIOS	ACCESORIOS			59
10081	ACCESORIOS	ACCESORIOS			59
10083	ACCESORIOS	ACCESORIOS			59
10084	ACCESORIOS	ACCESORIOS			59
24010	ACCESORIOS	ACCESORIOS			77
24020	ACCESORIOS	ACCESORIOS			77
24035	ACCESORIOS	ACCESORIOS			77
24060	ACCESORIOS	ACCESORIOS			77
24100	ACCESORIOS	ACCESORIOS			77
24125	ACCESORIOS	ACCESORIOS			77
24135	ACCESORIOS	ACCESORIOS			77
24150	ACCESORIOS	ACCESORIOS			77
24175	ACCESORIOS	ACCESORIOS			77
24200	ACCESORIOS	ACCESORIOS			77
24250	ACCESORIOS	ACCESORIOS			77
24350	ACCESORIOS	ACCESORIOS			77
24610	ACCESORIOS	ACCESORIOS			77
24615	ACCESORIOS	ACCESORIOS			77
24620	ACCESORIOS	ACCESORIOS			77
24625	ACCESORIOS	ACCESORIOS			77
24630	ACCESORIOS	ACCESORIOS			77
24640	ACCESORIOS	ACCESORIOS			77
24680	ACCESORIOS	ACCESORIOS			77
24710	ACCESORIOS	ACCESORIOS			77
24715	ACCESORIOS	ACCESORIOS			77
24720	ACCESORIOS	ACCESORIOS			77
24725	ACCESORIOS	ACCESORIOS			77
24730	ACCESORIOS	ACCESORIOS			77
24740	ACCESORIOS	ACCESORIOS			77
24780	ACCESORIOS	ACCESORIOS			77
36990	ACCESORIOS	ACCESORIOS			64
36991	ACCESORIOS	ACCESORIOS			64
50624	ACCESORIOS	ACCESORIOS			37
50625	ACCESORIOS	ACCESORIOS			37
50626	ACCESORIOS	ACCESORIOS			37
100757	BUILT	COLGANTES	LED		37
100763	GRASS	APLIQUES	LED		29
100764	CANADIAN	PLAFONES	LED		38
100765	CANADIAN	PLAFONES	LED		38
100795	PENN	BAÑADORES	LED		59
101182	BUILT	COLGANTES	LED		37
101183	GRASS	APLIQUES	LED		29
102795	PENN	BAÑADORES	LED		59
102796	PENN	BAÑADORES	LED		59
102797	PENN	BAÑADORES	LED		59
102798	PENN	BAÑADORES	LED		59
102799	PENN	BAÑADORES	LED		59
111050	THIN	PROYECTOR	LED		63
111051	THIN	PROYECTOR	LED		64
111058	COBSOIL	EMPOTRABLES	LED		46
111462	THIN	PROYECTOR	LED		63
111463	THIN	PROYECTOR	LED		63
112050	DOUCHE	EMPOTRABLES	LED		48
112052	DOUCHE	EMPOTRABLES	LED		48

REF	Nombre	tipo	LED	Casquillo	página
112180	NEW ERA	APLIQUES	LED		25
112262	NEKO	EXTERIOR SOLAR	LED		72
112262	NEKO	EXTERIOR SOLAR	LED		78
112271	TISA	APLIQUES	LED		27
112272	TISA	APLIQUES	LED		27
112287	TISA	APLIQUES	LED		27
112308	YUKA	PROYECTOR		GU10	67
112358	TISA	APLIQUES	LED		27
112432	KIPPER	EXTERIOR SOLAR	LED		75
112958	TISA	APLIQUES	LED		27
112972	TISA	APLIQUES	LED		27
113192	KAMAL	BAÑADORES	LED		54
200582	BIRD	EXTERIOR SOLAR	LED		73
200582	BIRD	EXTERIOR SOLAR	LED		79
200597	KIPPER	EXTERIOR SOLAR	LED		75
200677	KOA	APLIQUES	LED		30
200678	KOA	APLIQUES	LED		30
200679	KOA	APLIQUES	LED		30
200764	DARY	BALIZAS	LED		17
200766	SUKO	PLAFONES	LED		39
200775	SIA	BAÑADORES	LED		57
200776	KOA	APLIQUES	LED		30
200780	SIA	BAÑADORES	LED		57
250900	KAMAL	BAÑADORES	LED		55
250901	KAMAL	BAÑADORES	LED		55
300010	NALA	BALIZAS	LED		15
300011	NALA	BALIZAS	LED		15
365093	FAST	EMPOTRABLES	LED		49
365094	FAST	EMPOTRABLES	LED		49
365095	FAST	EMPOTRABLES	LED		49
365096	FAST	EMPOTRABLES	LED		49
400000	ARIS	EMPOTRABLES	LED		43
400005	OKO	EMPOTRABLES	LED		43
400006	INMA	EMPOTRABLES	LED		43
400008	INMA	EMPOTRABLES	LED		43
400045	NAYA	APLIQUES	LED		21
400052	HELIO	EXTERIOR SOLAR	LED		71
400061	NINA	APLIQUES	LED		19
400063	NINA	BALIZAS	LED		19
400064	DARY	BALIZAS	LED		17
400065	NAYA	BALIZAS	LED		21
400069	NINA	BALIZAS	LED		19
400072	LEIA	APLIQUES		E27	31
400073	LEIA	APLIQUES		E27	31
400076	HELIO	EXTERIOR SOLAR	LED		71
400086	LOBY	APLIQUES	LED		28
400087	LOBY	APLIQUES	LED		28
400088	LOBY	APLIQUES	LED		28
400089	BELY	BAÑADORES	LED		53
400090	BELY	BAÑADORES	LED		53
400091	YUKA	PROYECTORES		GU10	67
400092	LOBY	APLIQUES	LED		28
400095	LOBY	APLIQUES	LED		28
400103	ARIS	EMPOTRABLES	LED		43



REF	Nombre	tipo	LED	Casquillo	página	REF	Nombre	tipo	LED	Casquillo	página
400104	INMA	EMPOTRABLES	LED		43	400287	COBSOIL	EMPOTRABLES	LED		46
400105	INMA	EMPOTRABLES	LED		43	400288	COBSOIL	EMPOTRABLES	LED		46
400106	OKO	EMPOTRABLES	LED		43	400289	COBSOIL	EMPOTRABLES	LED		46
400110	BELY	BAÑADORES	LED		53	400290	COBSOIL	EMPOTRABLES	LED		46
400111	BELY	BAÑADORES	LED		53	400291	COBSOIL	EMPOTRABLES	LED		46
400112	BELY	BAÑADORES	LED		53	400292	COBSOIL	EMPOTRABLES	LED		46
400113	BELY	BAÑADORES	LED		53	400293	COBSOIL	EMPOTRABLES	LED		46
400114	BELY	BAÑADORES	LED		53	400294	COBSOIL	EMPOTRABLES	LED		46
400115	BELY	BAÑADORES	LED		53	400297	COBSOIL	EMPOTRABLES	LED		46
400116	BELY	BAÑADORES	LED		53	400298	COBSOIL	EMPOTRABLES	LED		46
400117	BELY	BAÑADORES	LED		53	400299	COBSOIL	EMPOTRABLES	LED		46
400118	BELY	BAÑADORES	LED		53	400300	THIN	PROYECTOR	LED		64
400119	BELY	BAÑADORES	LED		53	400301	THIN	PROYECTOR	LED		64
400200	KAMAL	BAÑADORES	LED		54	400302	THIN	PROYECTOR	LED		64
400201	KAMAL	BAÑADORES	LED		54	400303	THIN	PROYECTOR	LED		64
400202	NEW ERA	APLIQUES	LED		25	400304	THIN	PROYECTOR	LED		64
400203	NEW ERA	APLIQUES	LED		25	400305	THIN	PROYECTOR	LED		64
400204	NEW ERA	APLIQUES	LED		25	400400	COBSOIL	EMPOTRABLES	LED		46
400205	NEW ERA	APLIQUES	LED		25	400415	COBSOIL	EMPOTRABLES	LED		46
400206	NEW ERA	APLIQUES	LED		25	400416	COBSOIL	EMPOTRABLES	LED		46
400208	THIN	PROYECTOR	LED		64	400417	COBSOIL	EMPOTRABLES	LED		46
400213	COBSOIL	EMPOTRABLES	LED		45	400418	COBSOIL	EMPOTRABLES	LED		46
400214	COBSOIL	EMPOTRABLES	LED		45	400421	COBSOIL	EMPOTRABLES	LED		46
400215	COBSOIL	EMPOTRABLES	LED		45	400422	COBSOIL	EMPOTRABLES	LED		46
400216	COBSOIL	EMPOTRABLES	LED		45	400423	COBSOIL	EMPOTRABLES	LED		46
400217	COBSOIL	EMPOTRABLES	LED		46	400424	COBSOIL	EMPOTRABLES	LED		46
400218	COBSOIL	EMPOTRABLES	LED		46	400600	LOBY	APLIQUES	LED		28
400233	COBSOIL	EMPOTRABLES	LED		45	400900	REGA	APLIQUES		GU10	33
400234	COBSOIL	EMPOTRABLES	LED		45	400901	REGA	APLIQUES		GU10	33
400235	COBSOIL	EMPOTRABLES	LED		45	400902	REGA	APLIQUES		GU10	33
400236	COBSOIL	EMPOTRABLES	LED		45	400903	REGA	APLIQUES		GU10	33
400239	COBSOIL	EMPOTRABLES	LED		45	700200	LOPE	APLIQUES		E27	35
400240	COBSOIL	EMPOTRABLES	LED		45	700201	LOPE	APLIQUES		E27	35
400241	COBSOIL	EMPOTRABLES	LED		45	700202	LOPE	COLGANTES		E27	35
400242	COBSOIL	EMPOTRABLES	LED		45	901000	ACCESORIOS	ACCESORIOS			37
400245	COBSOIL	EMPOTRABLES	LED		45	940540	AQUARUM	EMPOTRABLES	LED		47
400246	COBSOIL	EMPOTRABLES	LED		45						
400247	COBSOIL	EMPOTRABLES	LED		45						
400248	COBSOIL	EMPOTRABLES	LED		45						
400251	COBSOIL	EMPOTRABLES	LED		45						
400252	COBSOIL	EMPOTRABLES	LED		45						
400253	COBSOIL	EMPOTRABLES	LED		45						
400254	COBSOIL	EMPOTRABLES	LED		45						
400257	COBSOIL	EMPOTRABLES	LED		45						
400258	COBSOIL	EMPOTRABLES	LED		45						
400259	COBSOIL	EMPOTRABLES	LED		45						
400260	THIN	PROYECTOR	LED		64						
400261	THIN	PROYECTOR	LED		64						
400262	THIN	PROYECTOR	LED		64						
400263	THIN	PROYECTOR	LED		64						
400264	THIN	PROYECTOR	LED		64						
400269	COBSOIL	EMPOTRABLES	LED		45						
400281	COBSOIL	EMPOTRABLES	LED		46						
400282	COBSOIL	EMPOTRABLES	LED		46						

SÚLION







S Û L I O N